

INSWING TILT & TURN WINDOW

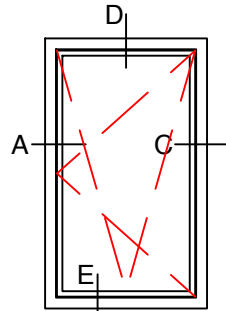

680-11-TT

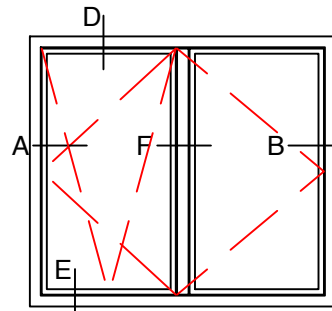

680-21-FR-TT
*SECONDARY UNABLE TO TILT

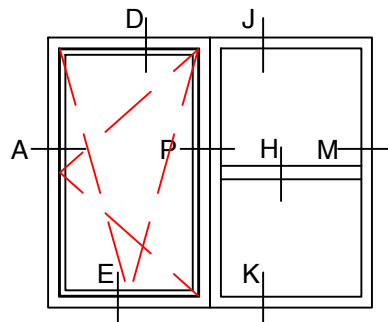

680-22-TT-FX

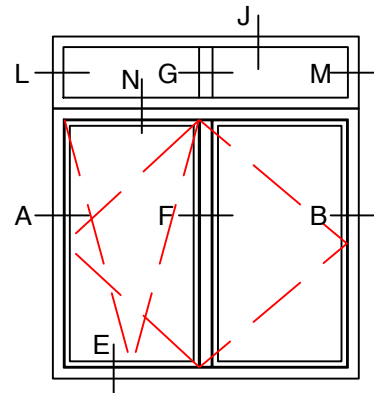

680-22-FR-TT-FX
*SECONDARY UNABLE TO TILT

INSWING TILT & TURN WINDOW

KEY (TYPICAL)

1. SNAP IN ALUMINUM GLAZING BEAD
2. WEDGE GASKET
3. 1" GLASS AND GLAZING (BY OTHERS)
4. WEATHER STRIPPING
5. METRO TILT & TURN HINGE
*TILT & TURN HARDWARE IS CONCEALED
6. METRO HANDLE

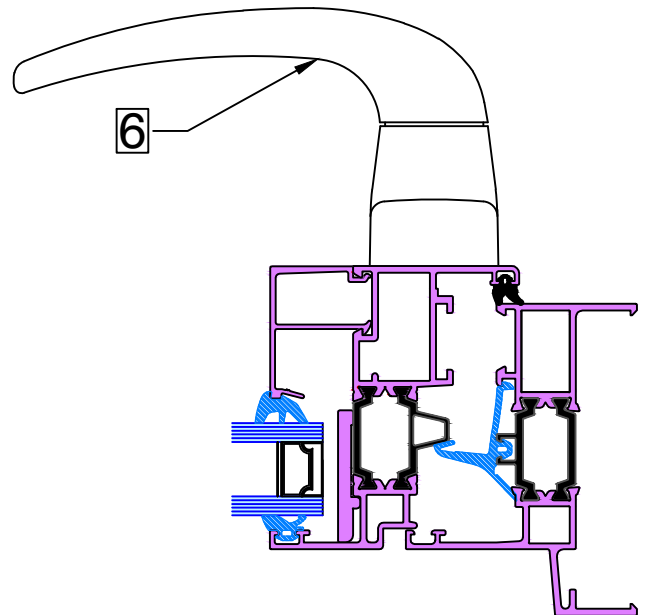
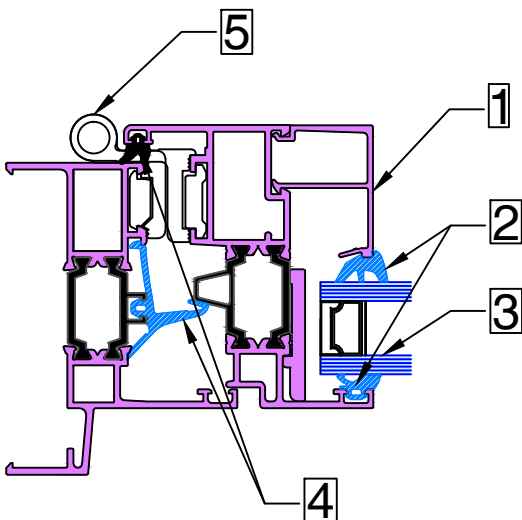

INSWING TILT & TURN WINDOW

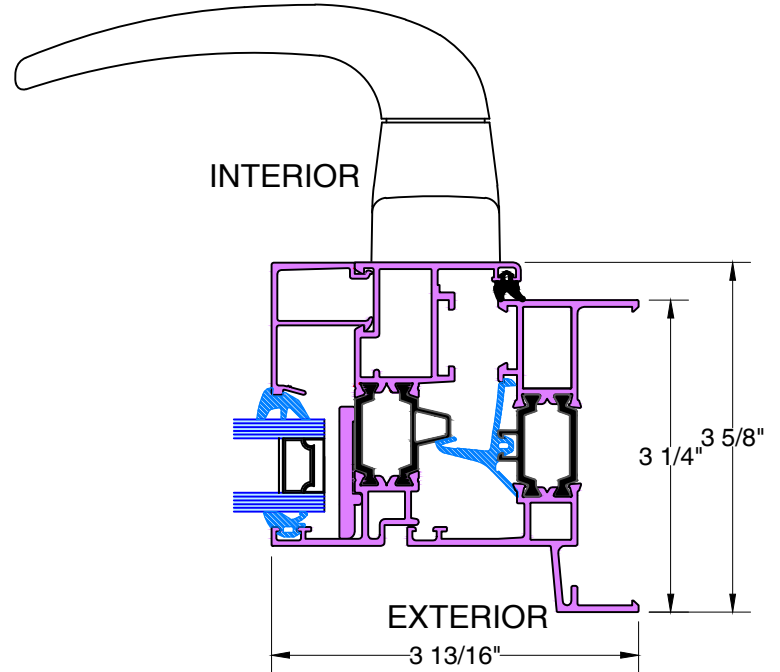
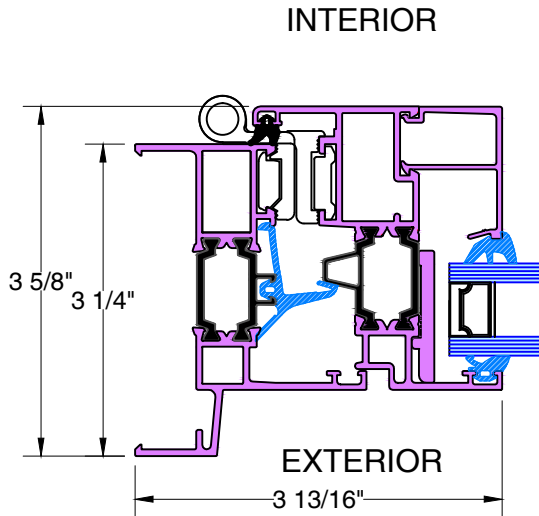

A&B TYPICAL HINGED JAMB

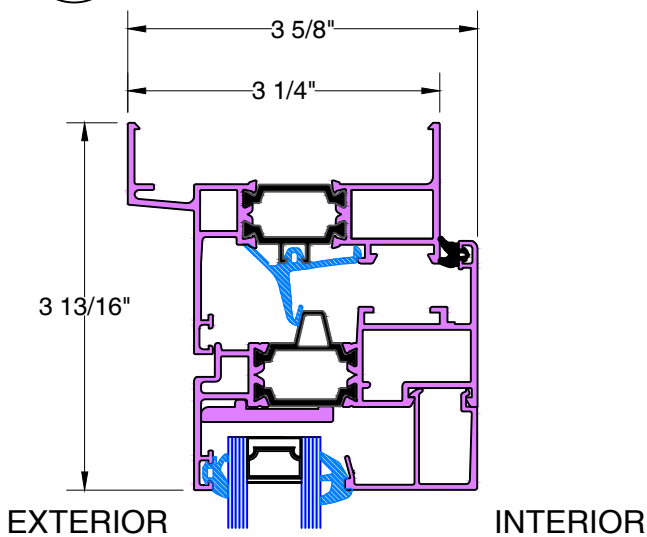

C TYPICAL LOCKING JAMB

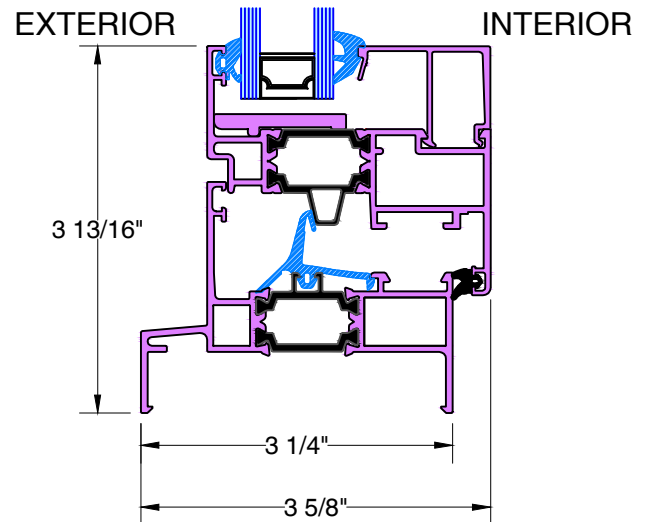

D TYPICAL HEAD

E TYPICAL SILL

INSWING TILT & TURN WINDOW

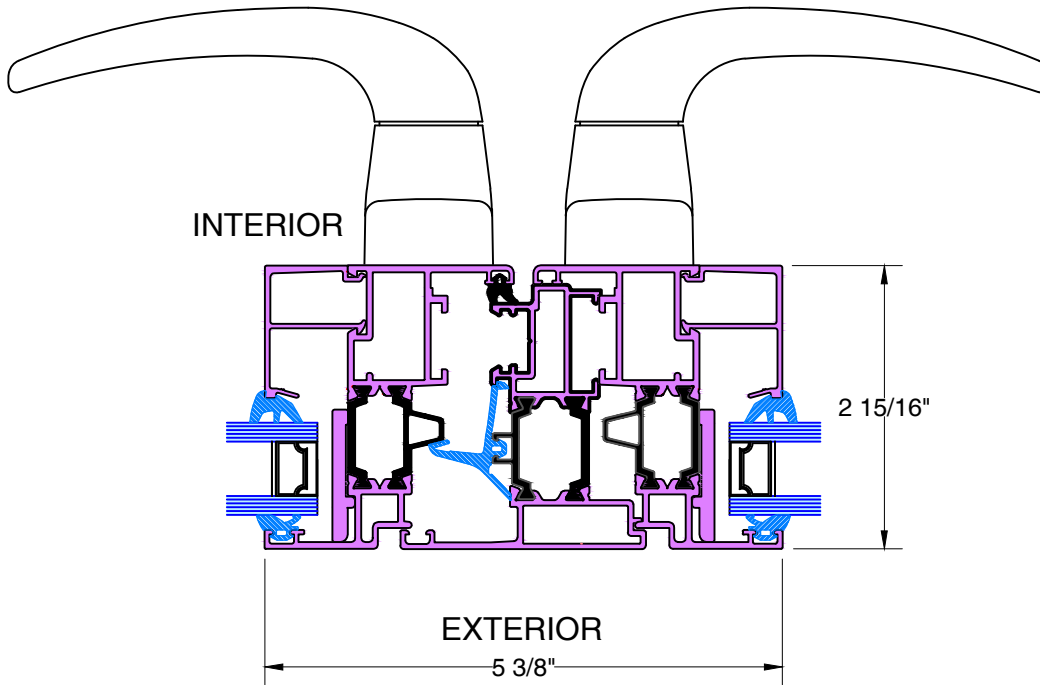

F TYPICAL FRENCH MEETING RAIL

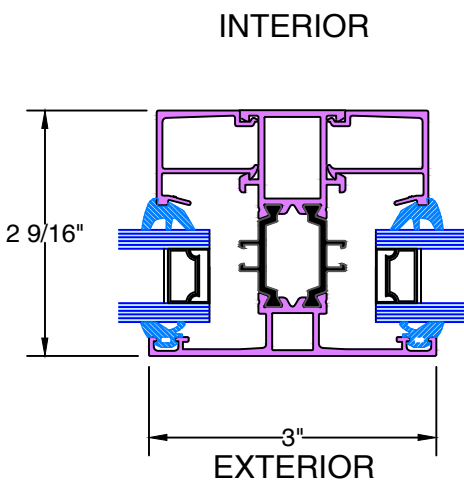

G TYPICAL VERTICAL MUNTIN

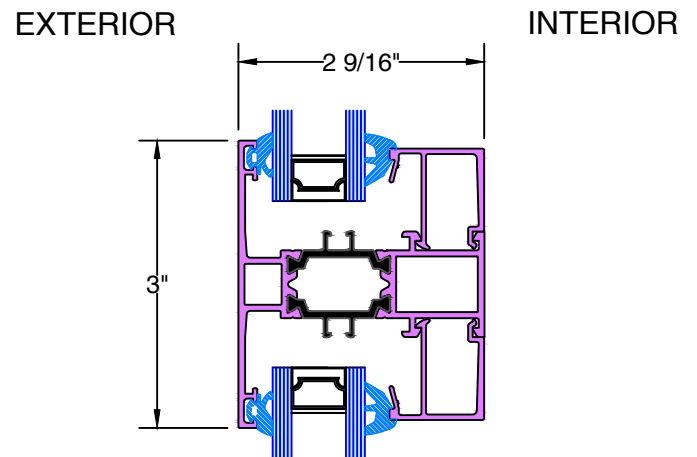

H TYPICAL HORIZONTAL MUNTIN

INSWING TILT & TURN WINDOW

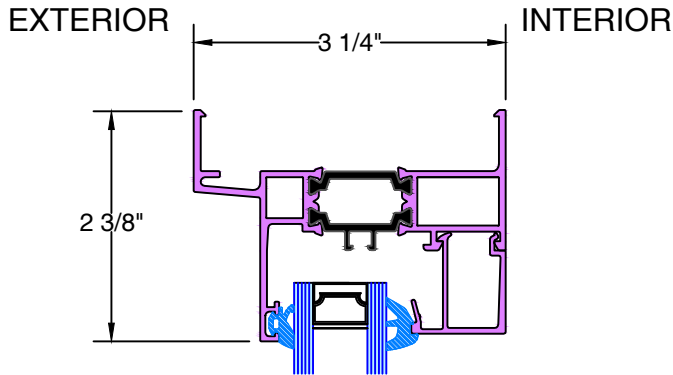

J&K TYPICAL FIXED HEAD & SILL

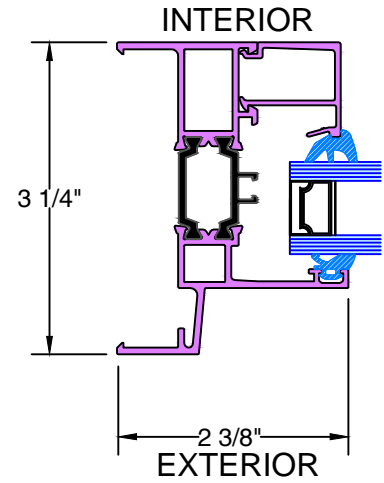

L&M TYPICAL FIXED JAMB

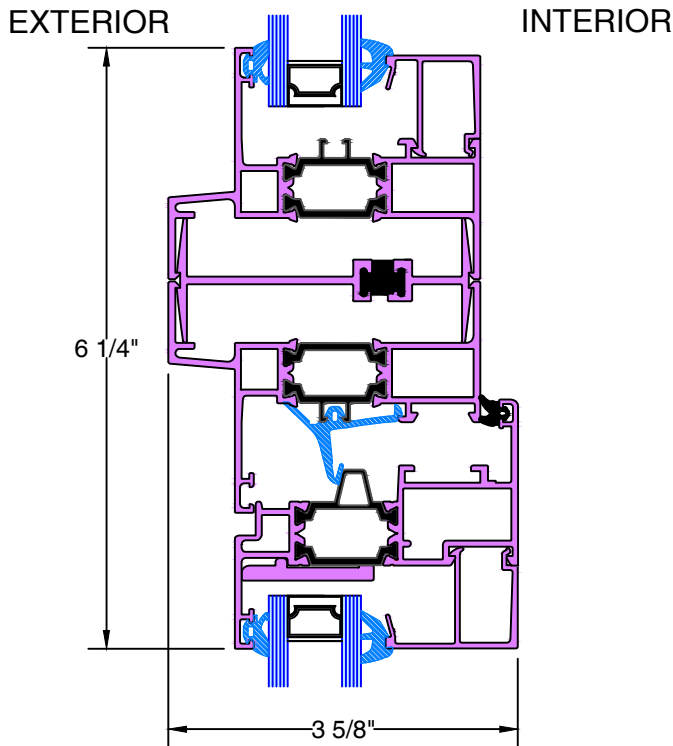

N TYPICAL STACKING MULLION

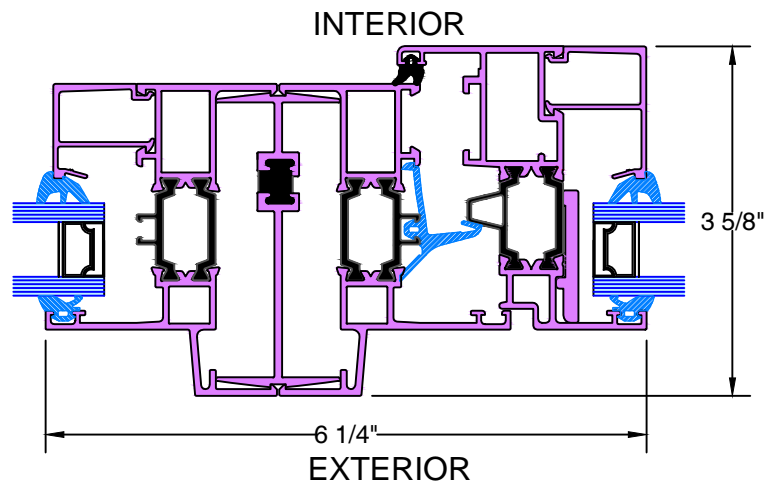

P TYPICAL JOINING MULLION