

OUTSWING CASEMENT

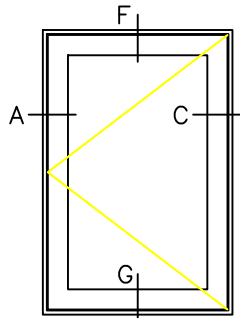

6511-OC

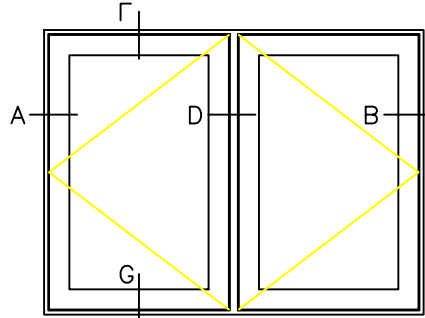

6521-DB-OC

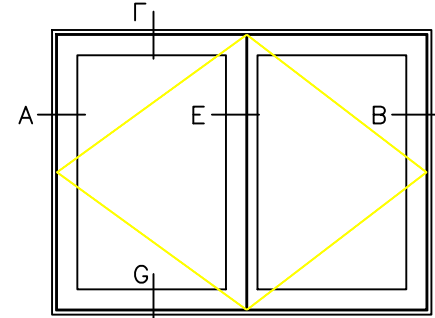

6521-FR-OC

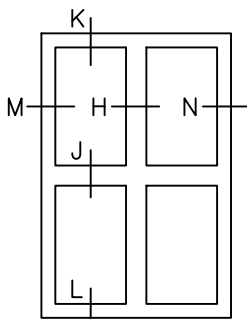

6522-FX

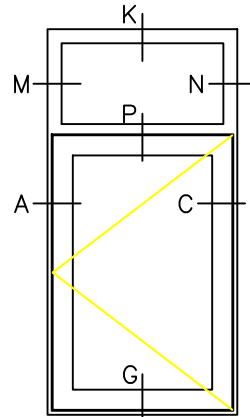

6512-OC-FX

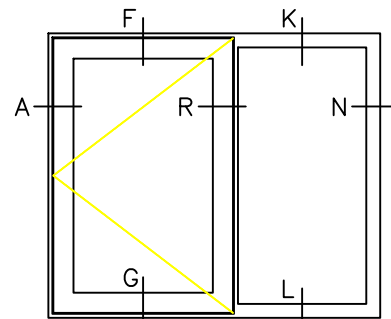

6521-OC-FX

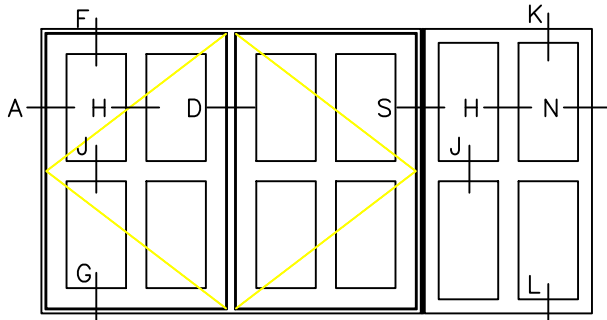

6562-DB-OC-FX

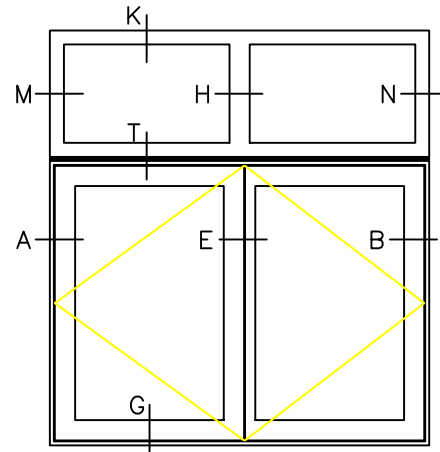

6522-FR-OC-FX

OUTSWING CASEMENT

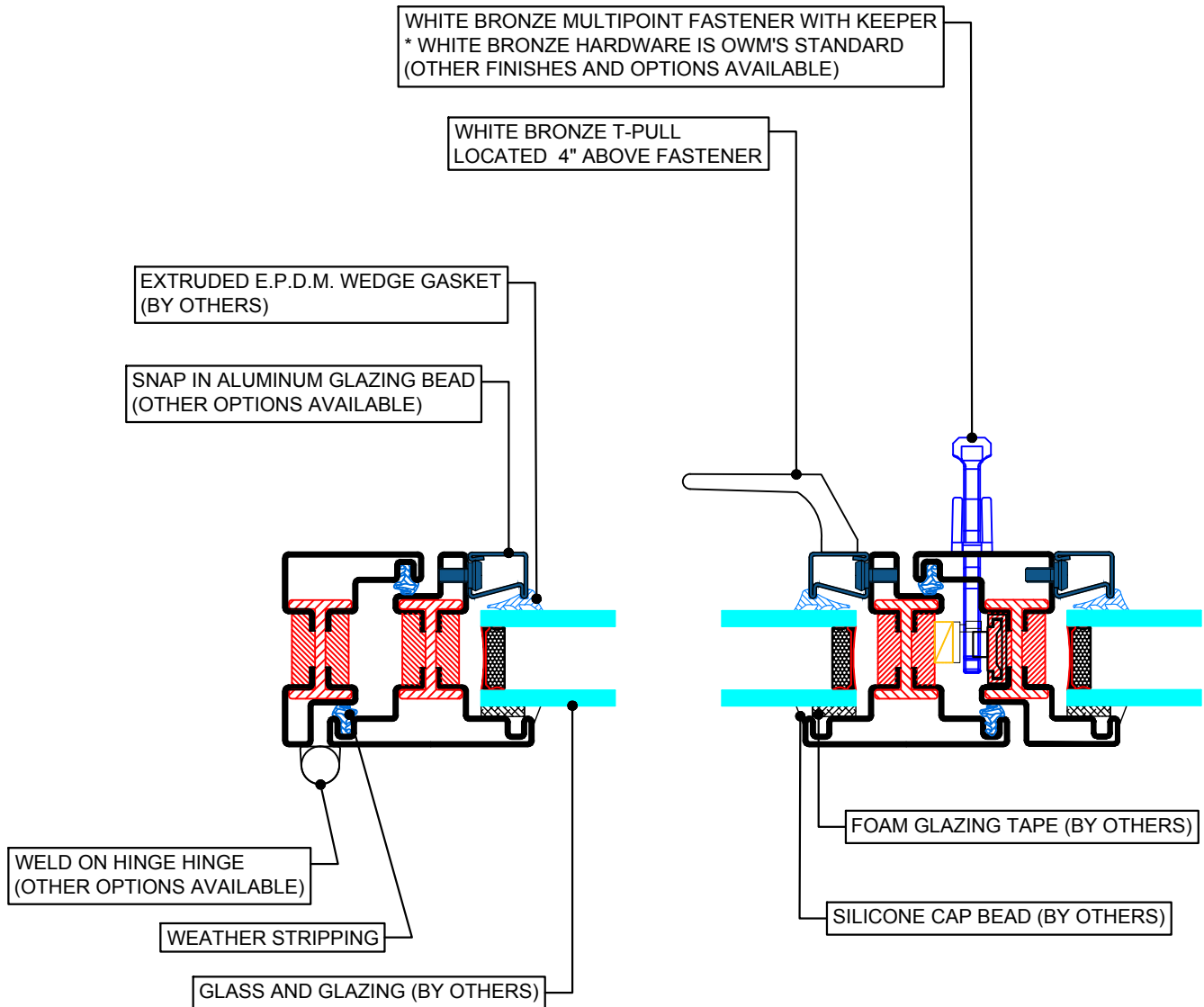

OUTSWING CASEMENT

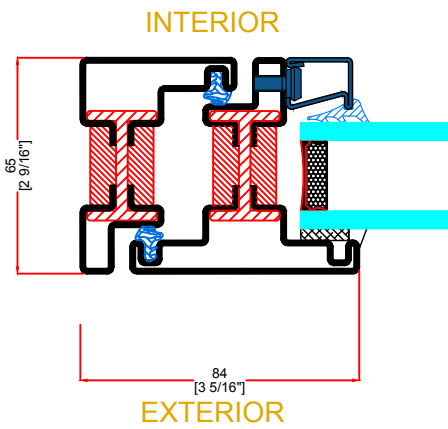

A&B — TYPICAL
HINGED JAMB

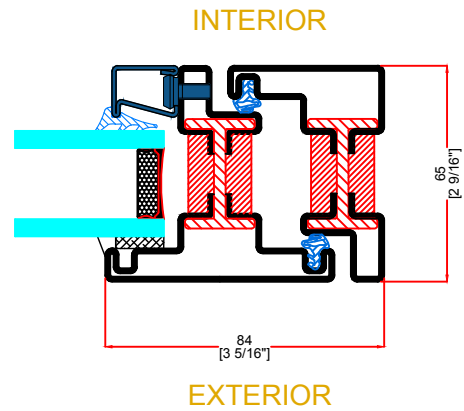

C — TYPICAL
LOCKING JAMB

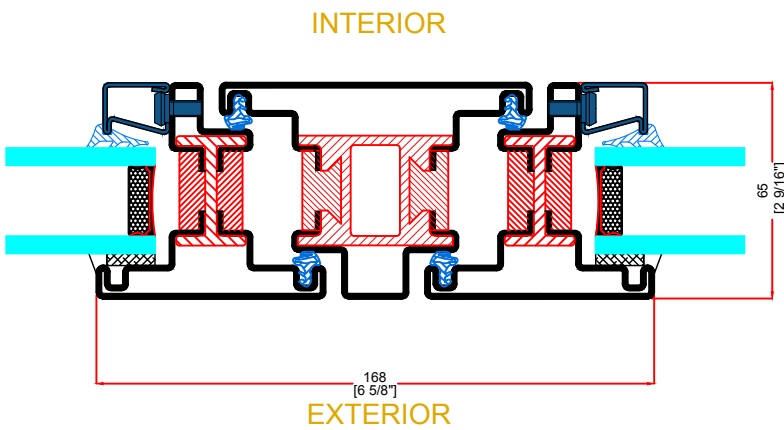

D — TYPICAL
MEETING RAIL

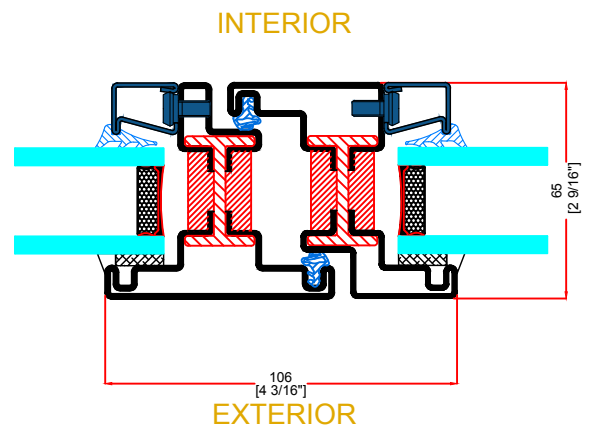

E — TYPICAL FRENCH
MEETING RAIL



OUTSWING CASEMENT

EXTERIOR INTERIOR

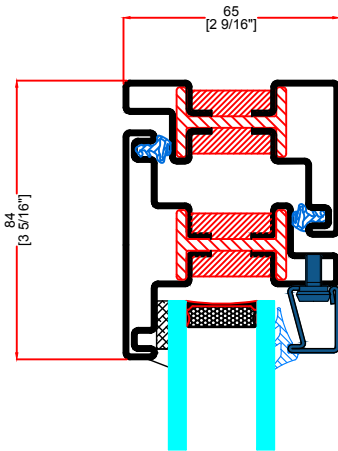

F TYPICAL HEAD

EXTERIOR INTERIOR

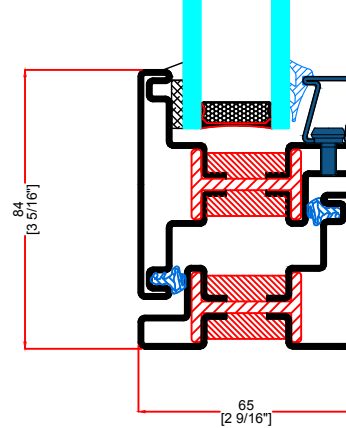

G TYPICAL SILL

INTERIOR

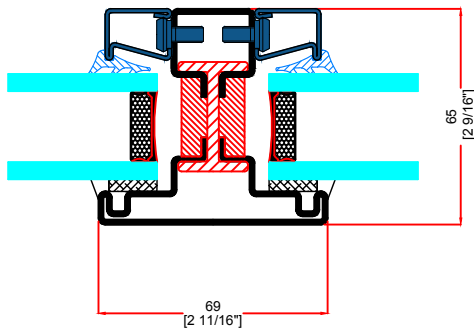

EXTERIOR

H TYPICAL VERTICAL MUNTIN

EXTERIOR INTERIOR

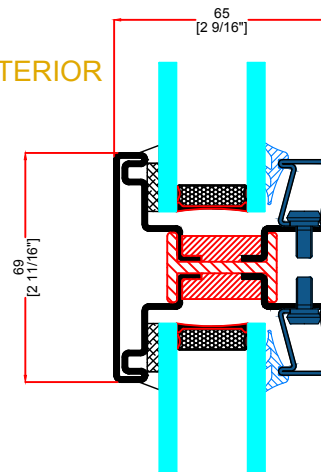

J TYPICAL HORIZONTAL MUNTIN

OUTSWING CASEMENT

EXTERIOR

INTERIOR

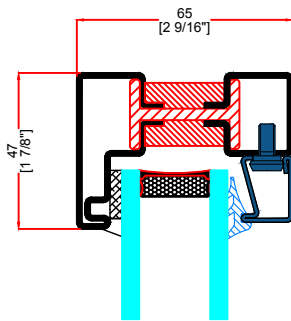

K&L TYPICAL FIXED HEAD & SILL

INTERIOR

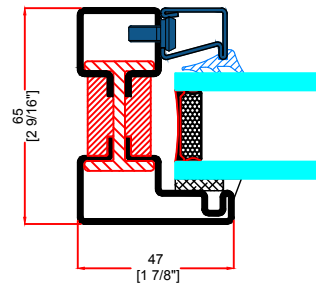

EXTERIOR

M&N TYPICAL FIXED JAMB

EXTERIOR

INTERIOR

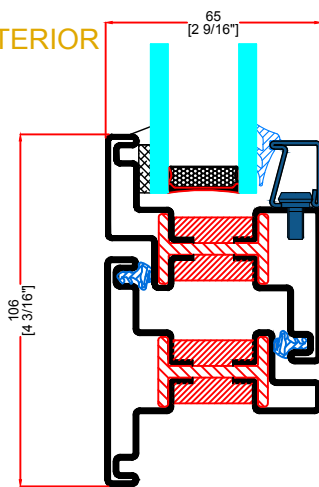

P TYPICAL STACKING TRANSOM

INTERIOR

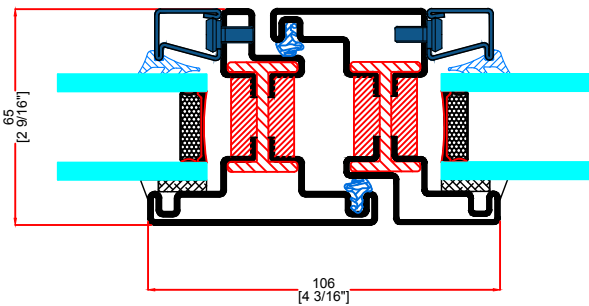

EXTERIOR

R TYPICAL JOINING SIDELITE



GLAZING BEADS

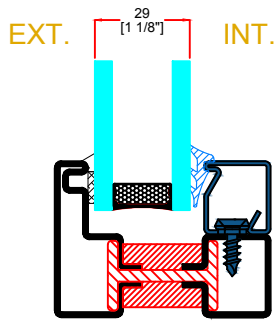

GB-1007
GLAZING BEAD

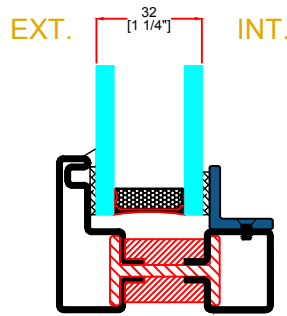

GB18-.75
GLAZING BEAD

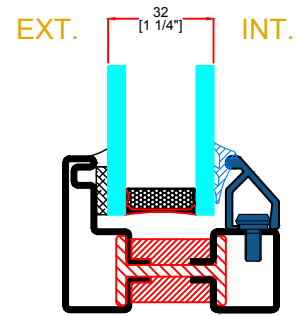

GB-1015
GLAZING BEAD

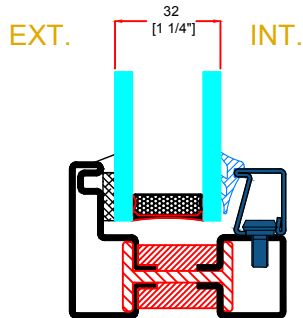

GB-2007
GLAZING BEAD

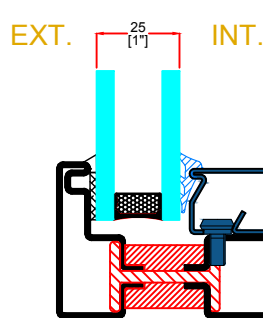

GB-2008
GLAZING BEAD



OUTSWING CASEMENT

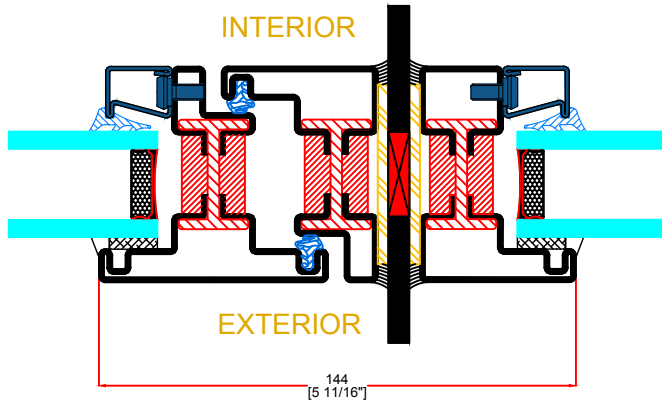

S TYPICAL JOINING MULLION

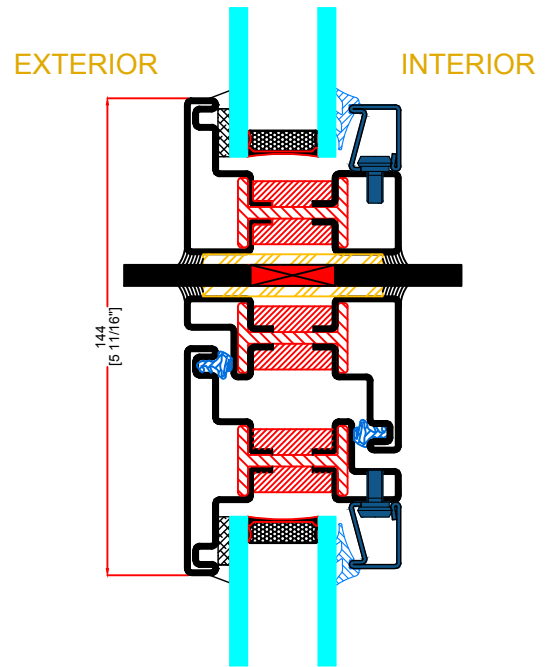

T TYPICAL STACKING TRANSOM

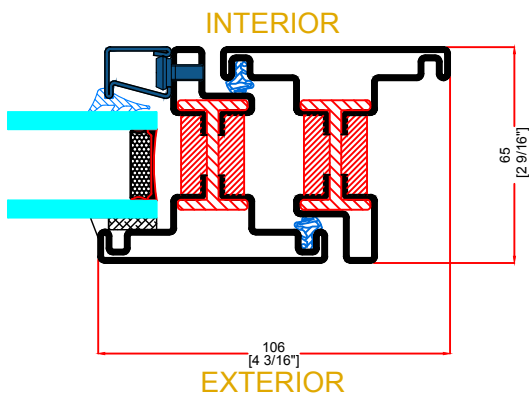

1 TYPICAL JAMB INTERIOR FLANGE

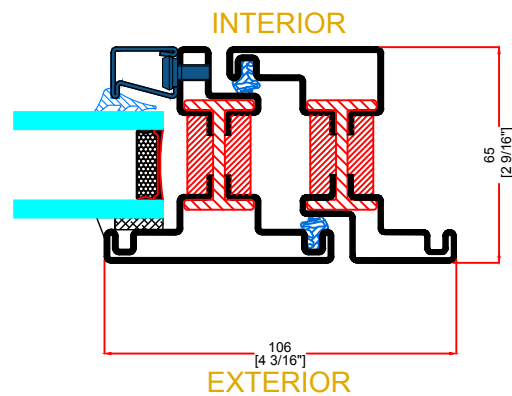

2 TYPICAL JAMB EXTERIOR FLANGE