

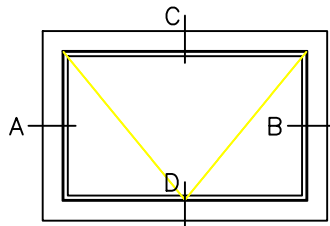

PROJECT-IN WINDOW

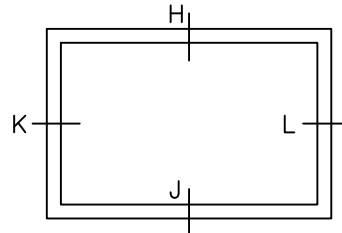

6511-PI



6511-FX

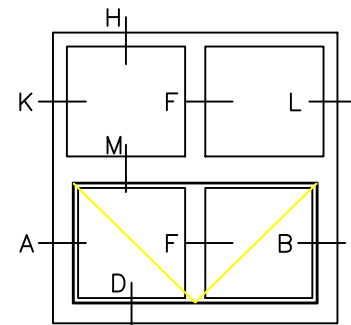

6522-PI-FX

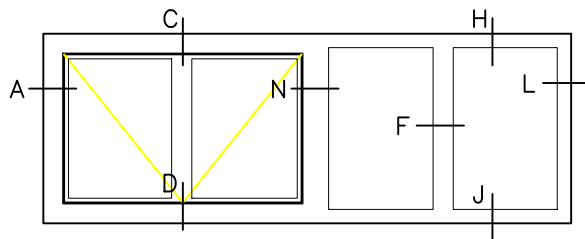

6541-PI-FX

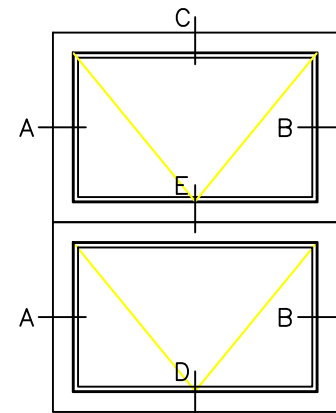

6512-PI-PI

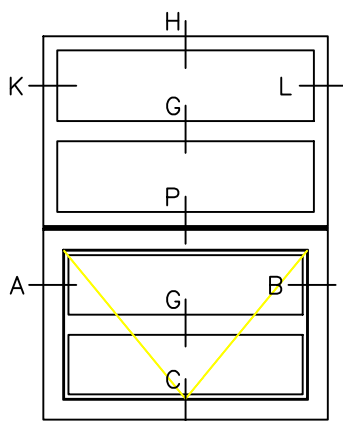

6514-PI-FX

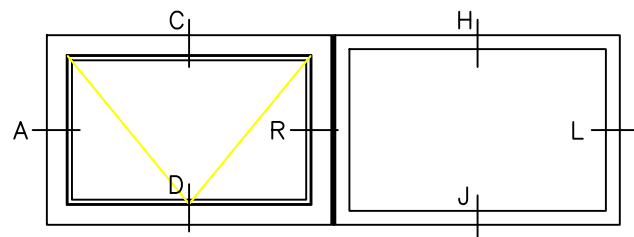

6521-PI-FX

PROJECT-IN WINDOW

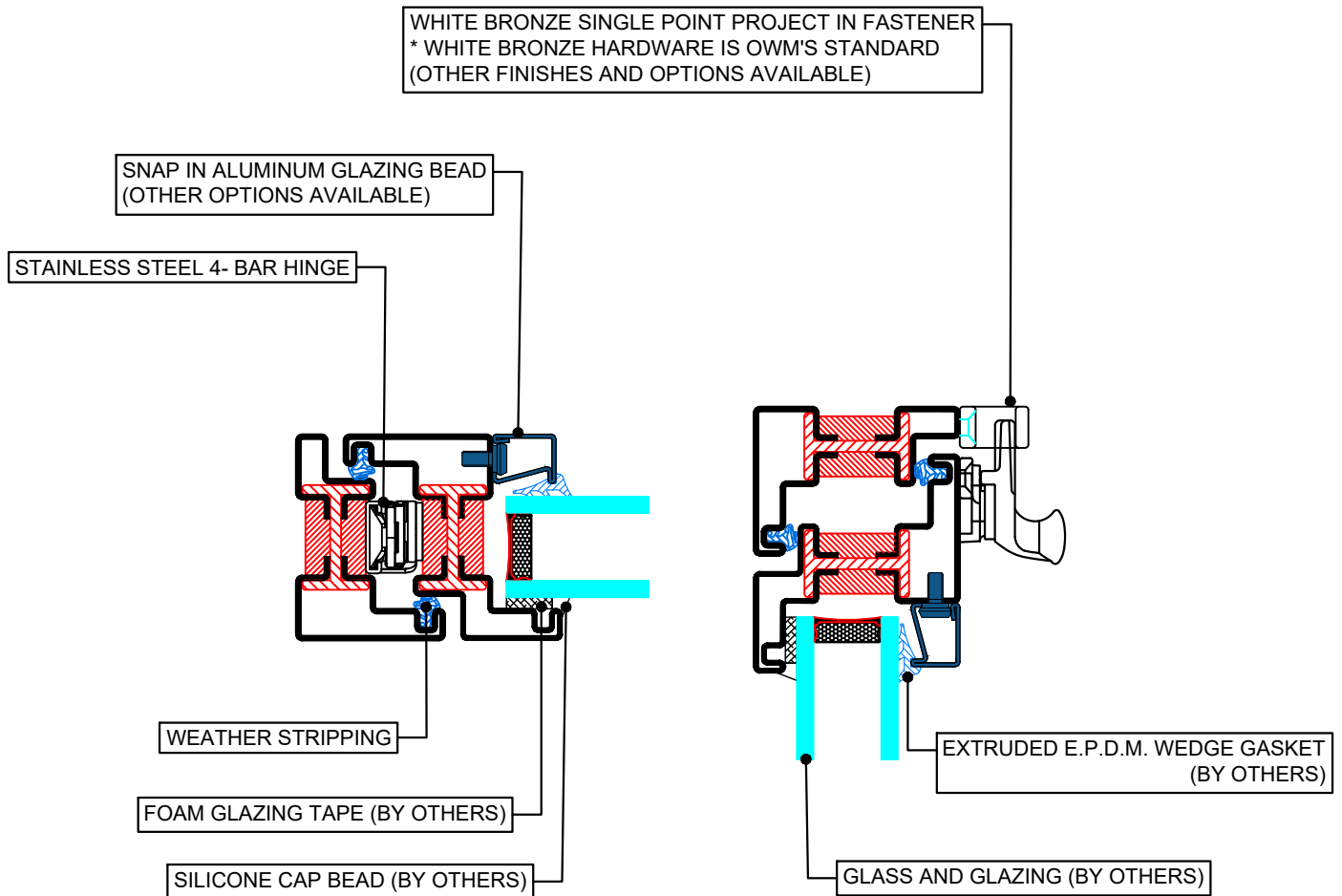



PROJECT-IN WINDOW

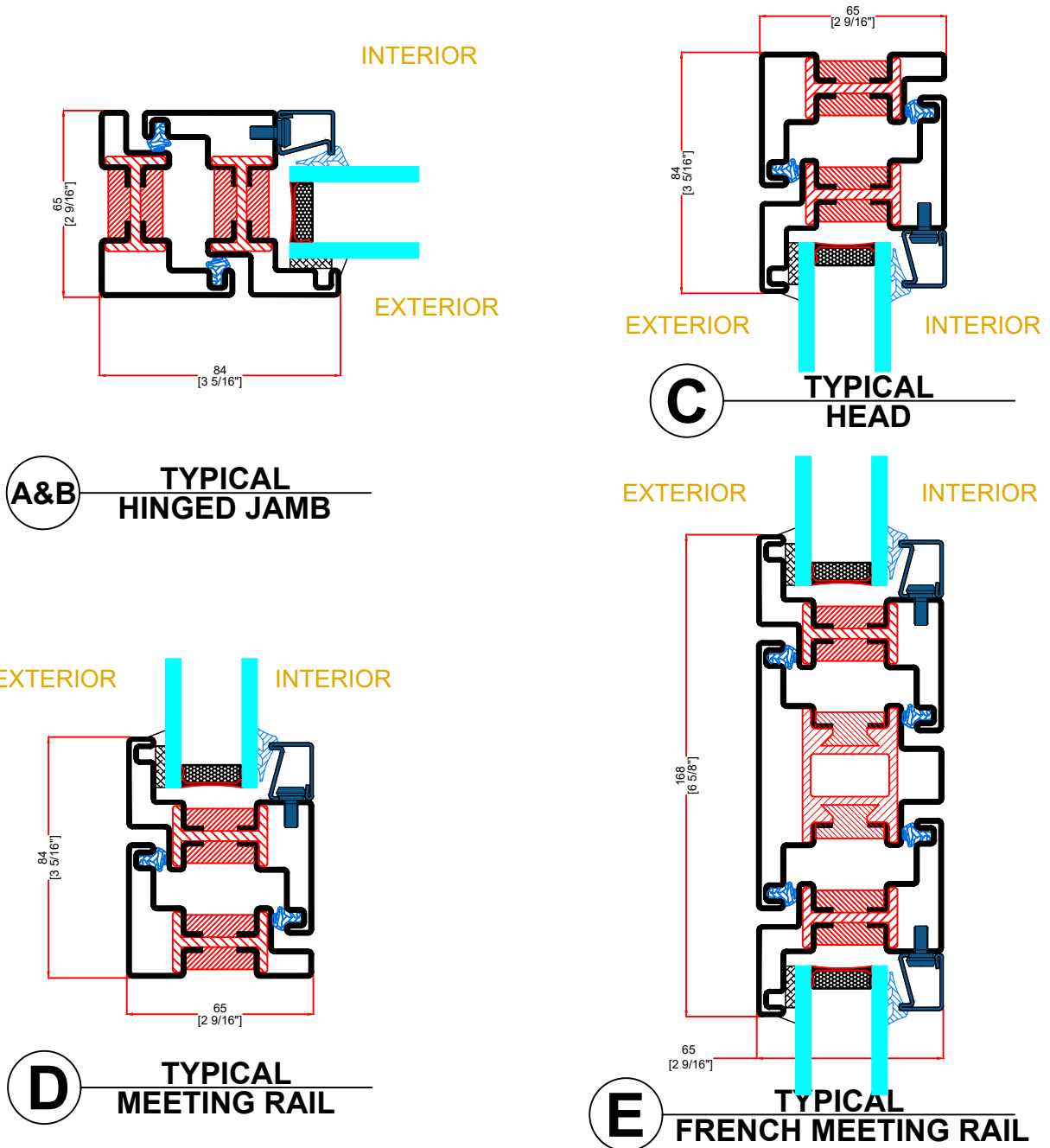



PROJECT-IN WINDOW

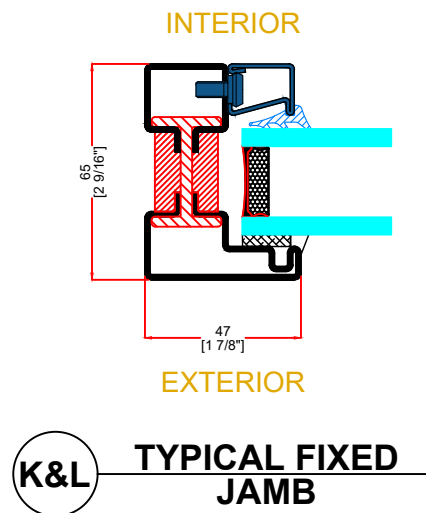
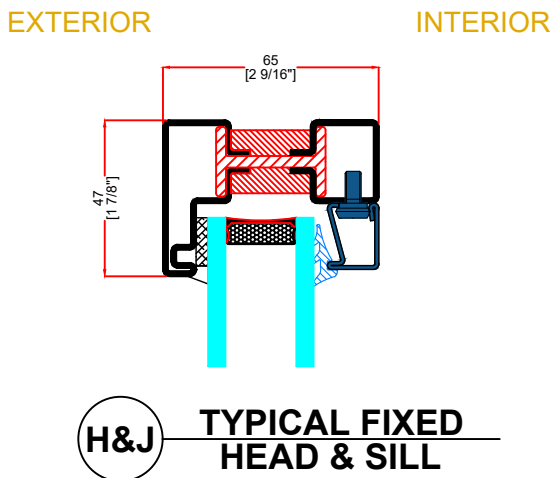
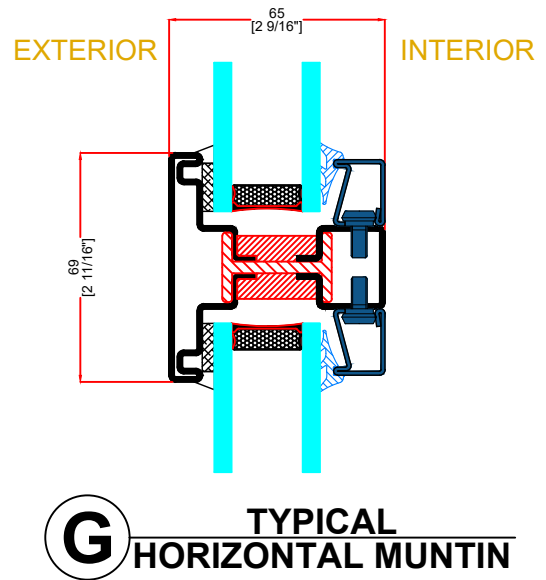
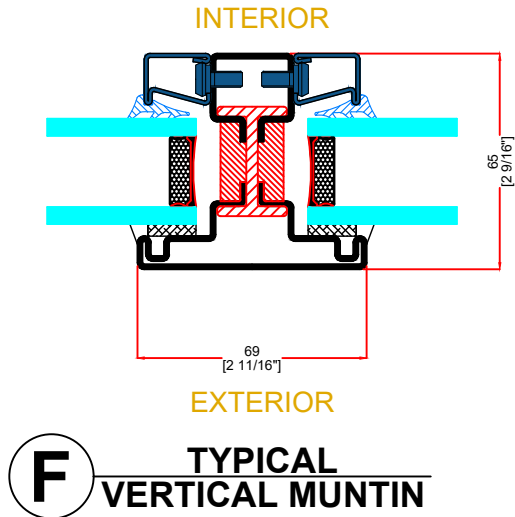

PROJECT-IN WINDOW

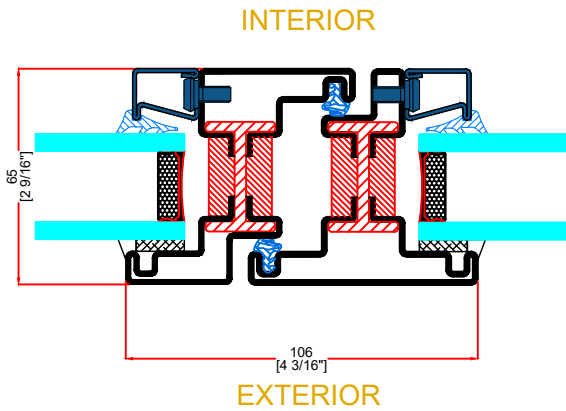

M TYPICAL JAMB WITH SIDELITE

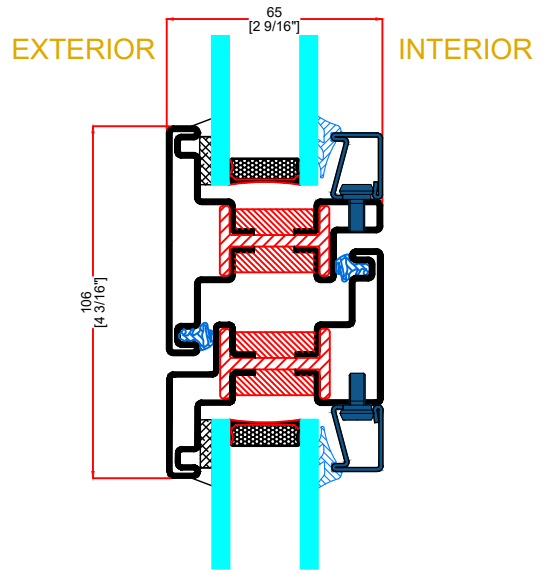

N TYPICAL HEAD WITH TRANSOM

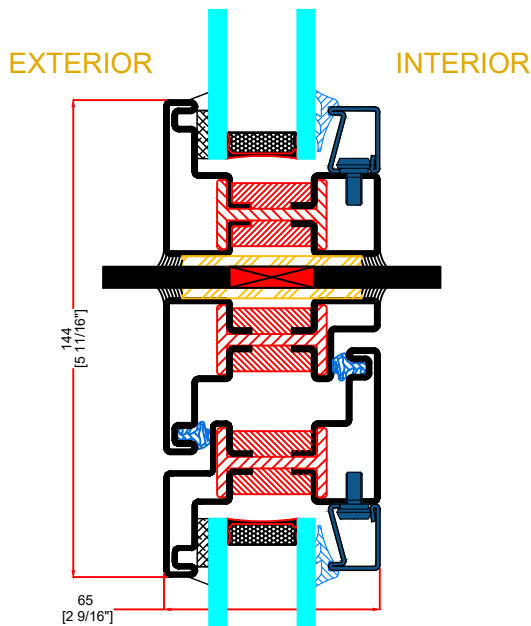

P TYPICAL STACKING MULLION

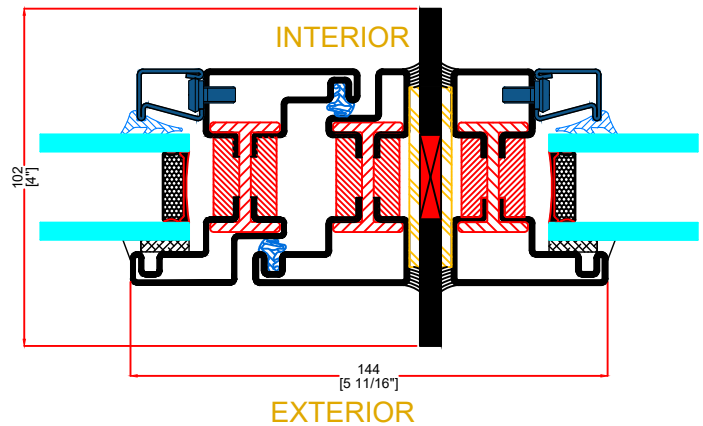

R TYPICAL JOINING MULLION



PROJECT-IN WINDOW

OPTIONAL FLANGE FRAMES

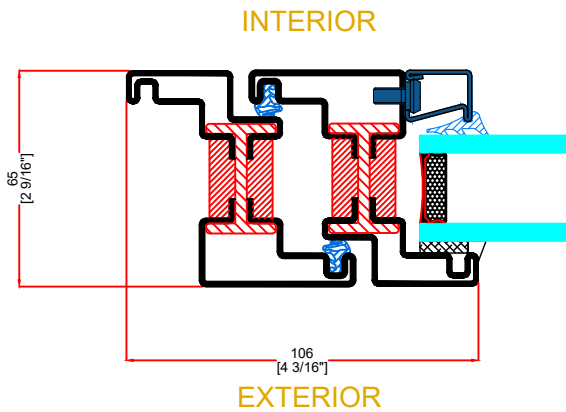

1 TYPICAL JAMB INTERIOR FLANGE

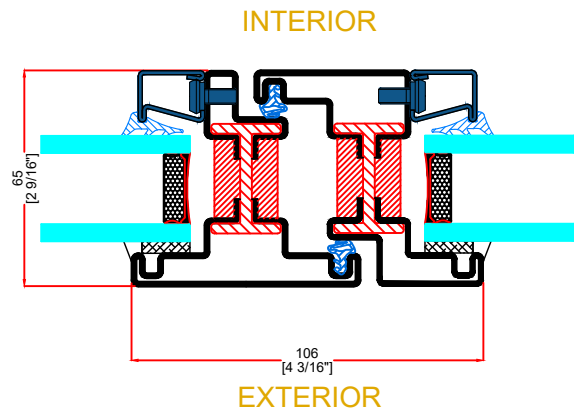

2 TYPICAL JAMB EXTERIOR FLANGE

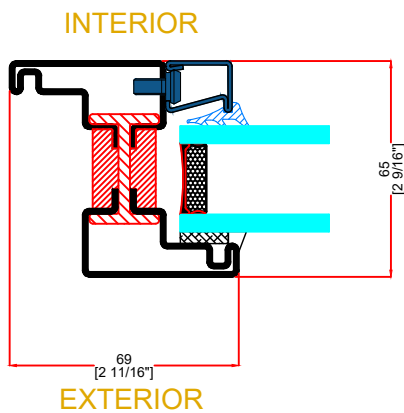

3 TYPICAL FIXED INTERIOR FLANGE

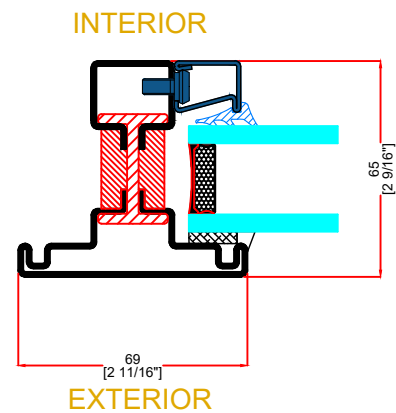

4 TYPICAL FIXED EXTERIOR FLANGE



GLAZING BEADS

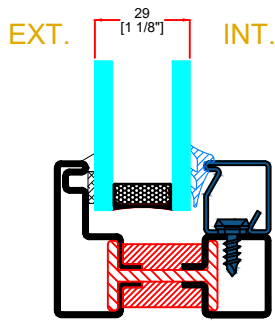

GB-1007
GLAZING BEAD

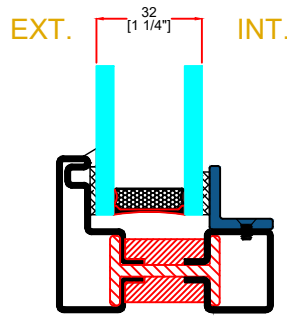

GB18-.75
GLAZING BEAD

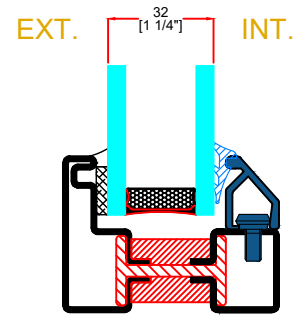

GB-1015
GLAZING BEAD

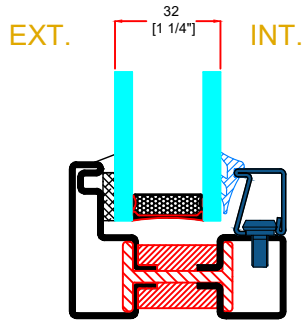

GB-2007
GLAZING BEAD

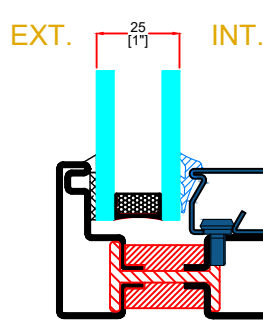

GB-2008
GLAZING BEAD