

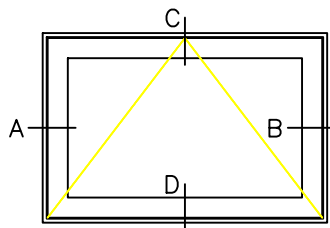

# PROJECT-OUT WINDOW

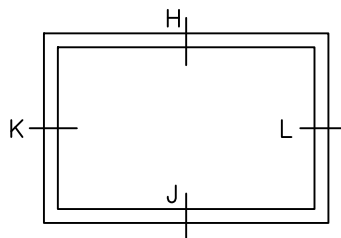

6511-PO



6511-FX

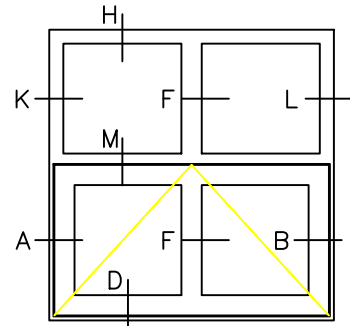

6522-PO-FX

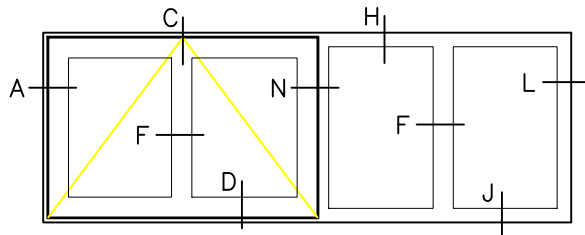

6541-PO-FX

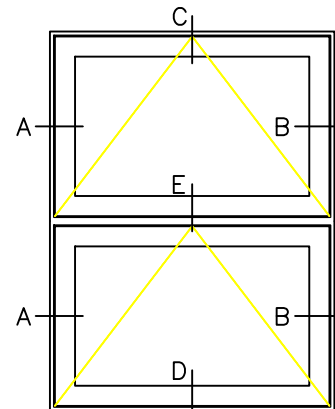

6512-PO-PO

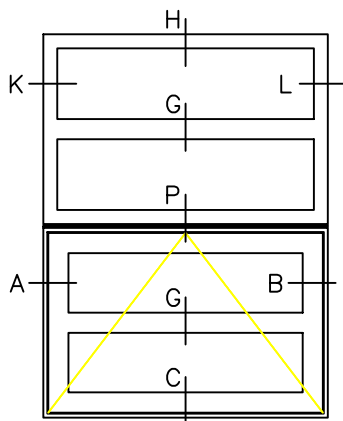

6514-PO-FX

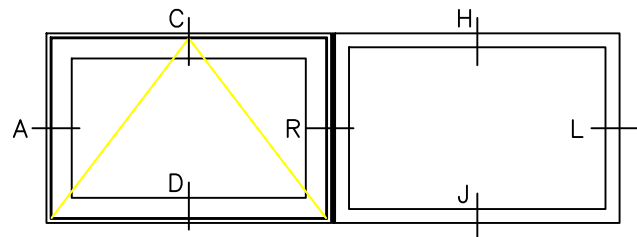

6521-PO-FX



# PROJECT-OUT WINDOW

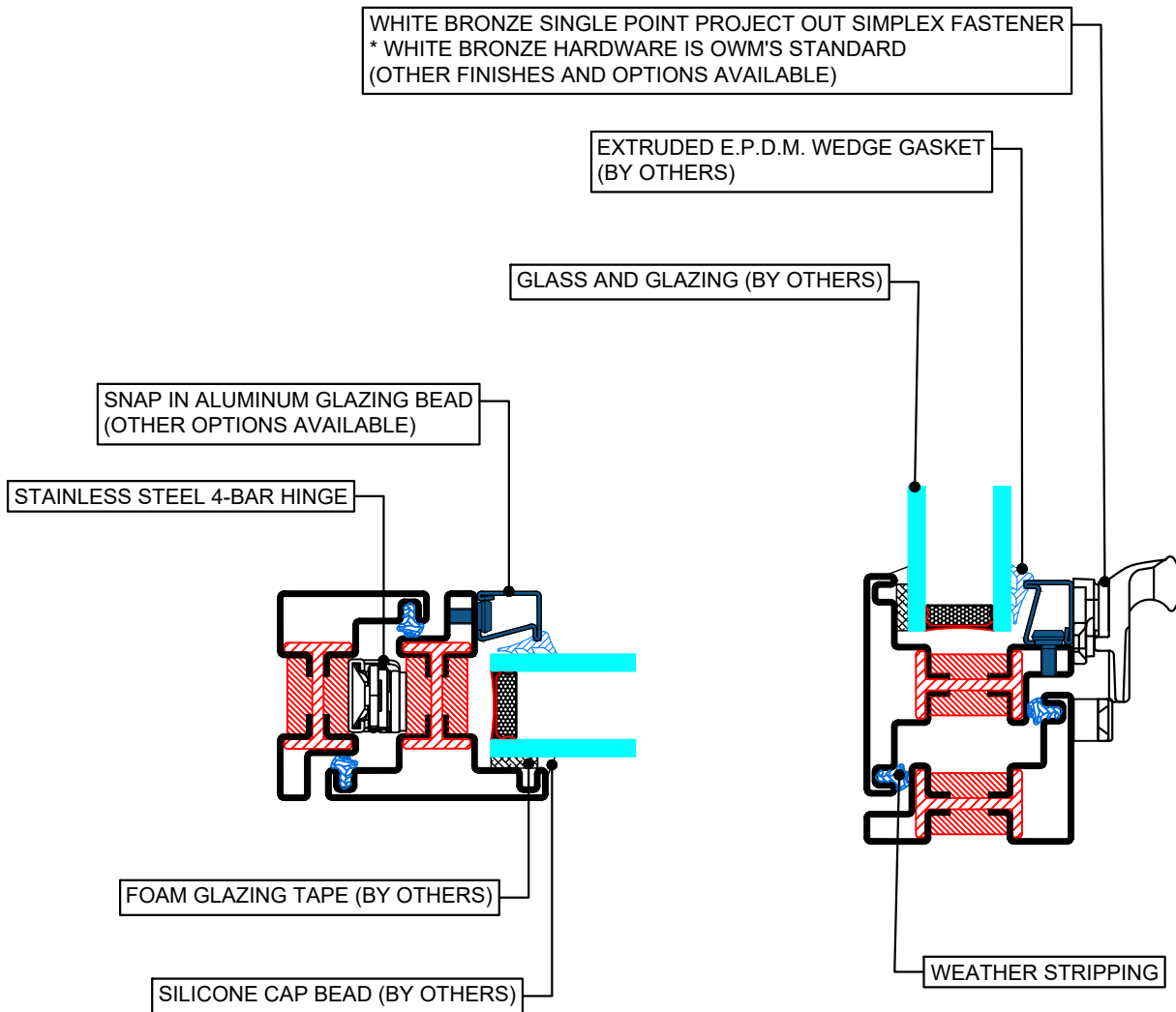



PROJECT-OUT WINDOW

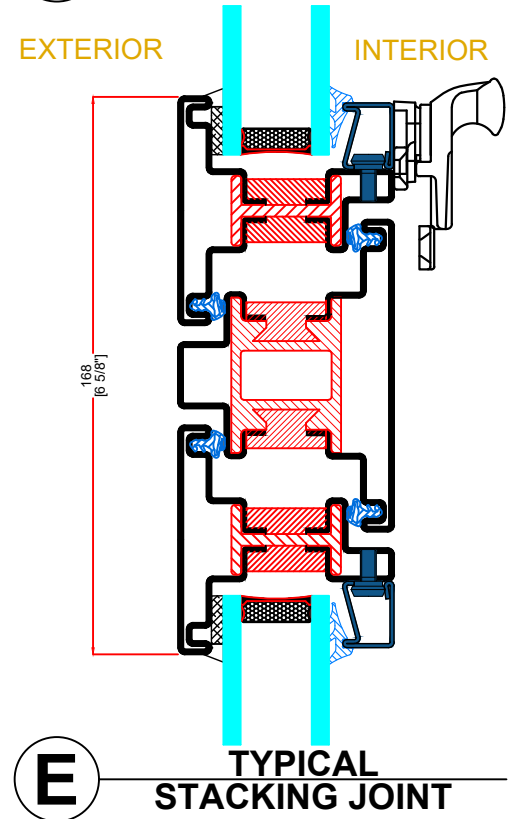
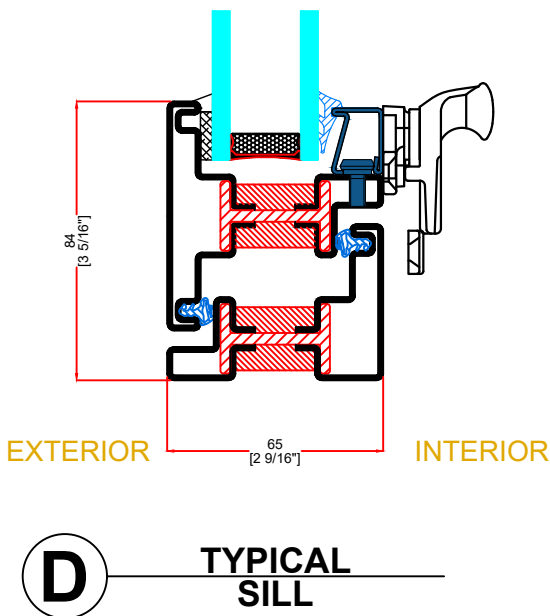
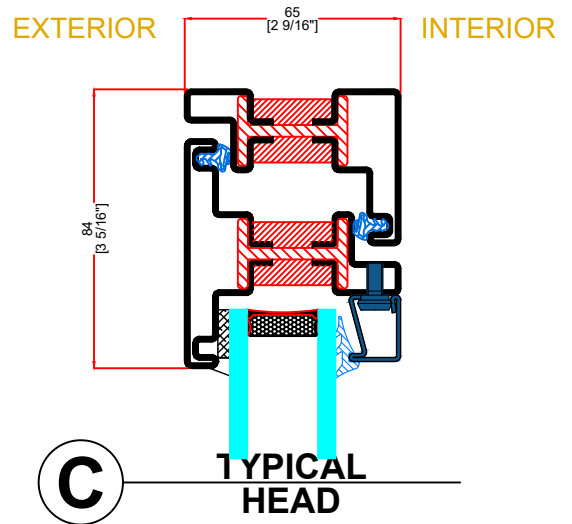
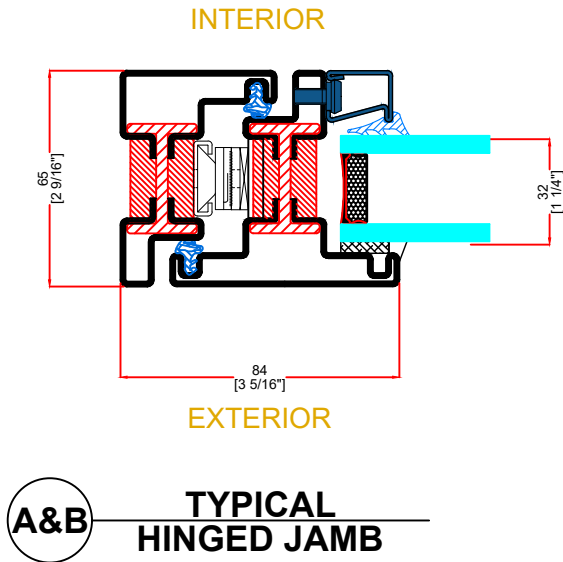



PROJECT-OUT WINDOW

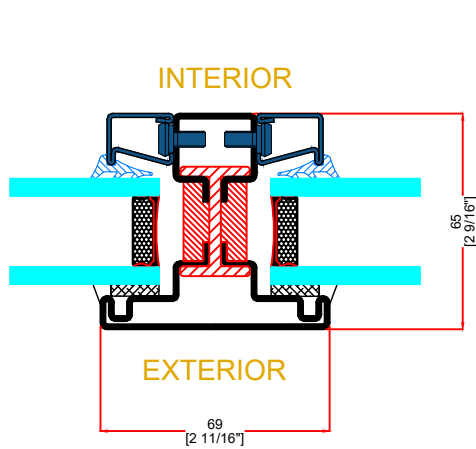

**F** TYPICAL VERTICAL MUNTIN

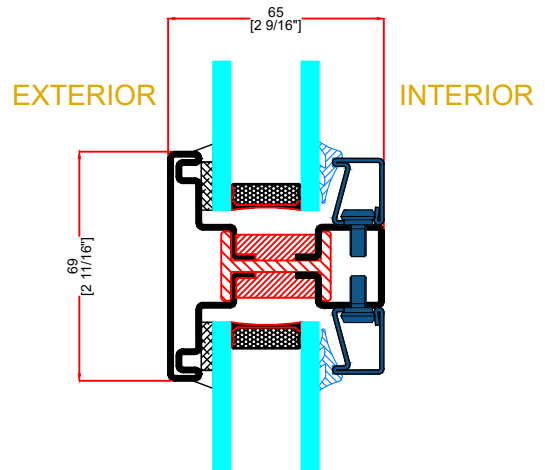

**G** TYPICAL HORIZONTAL MUNTIN

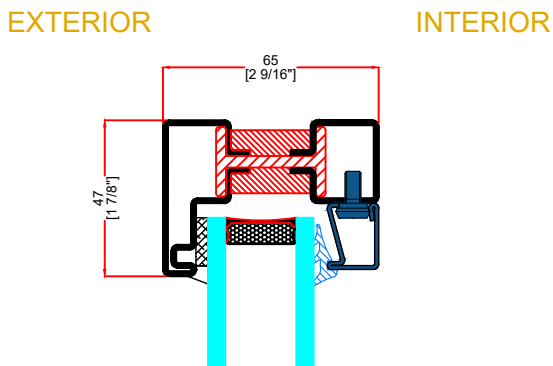

**H&J** TYPICAL FIXED HEAD & SILL

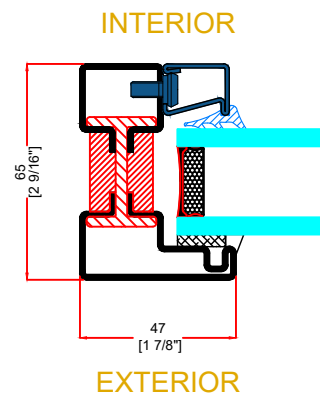

**K&L** TYPICAL FIXED JAMB

## PROJECT-OUT WINDOW

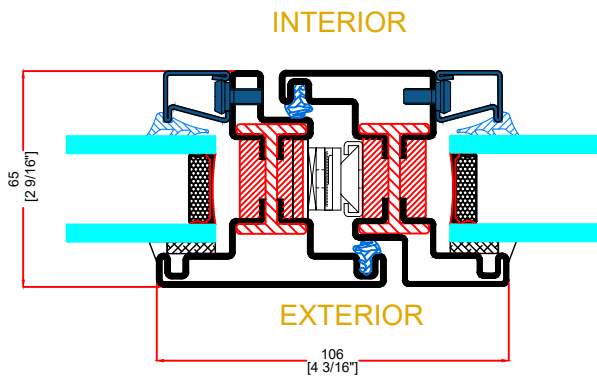

**M** TYPICAL JAMB WITH SIDELITE

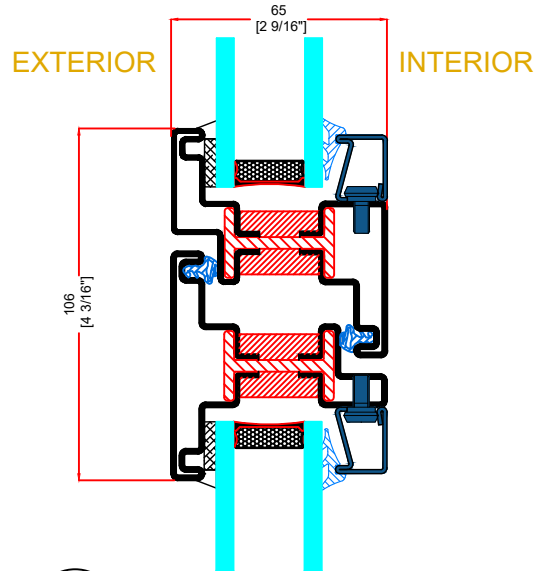

**N** TYPICAL HEAD WITH TRANSOM

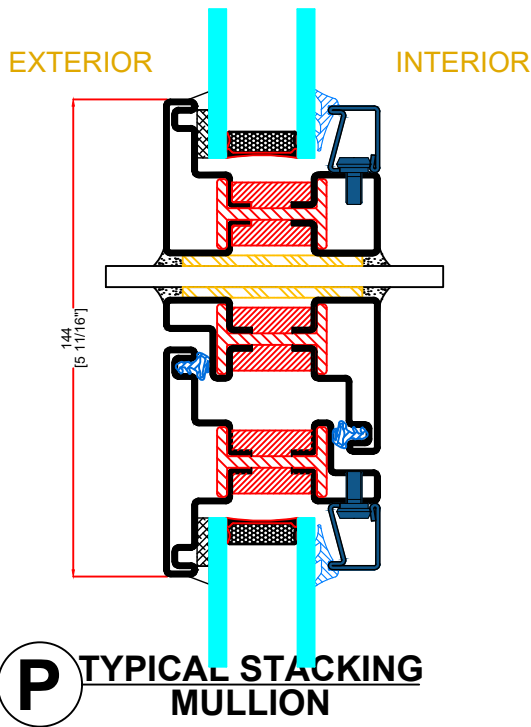

**P** TYPICAL STACKING MULLION

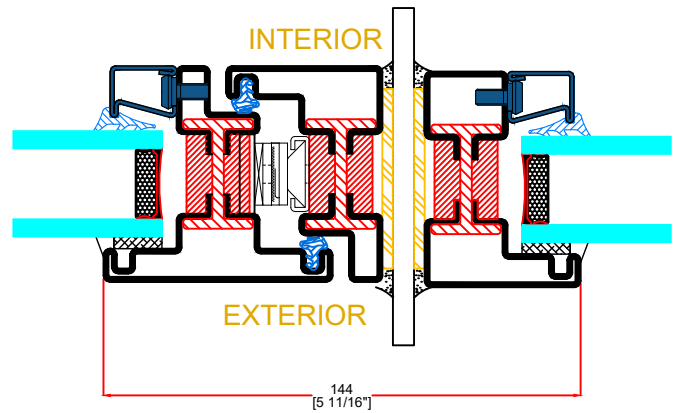

**R** TYPICAL JOINING MULLION



PROJECT-OUT WINDOW

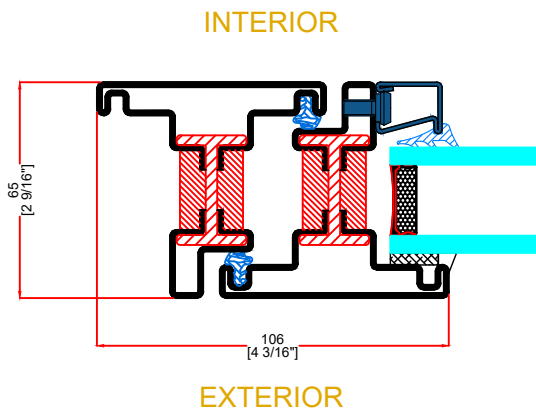

**1** TYPICAL JAMB  
INTERIOR FLANGE

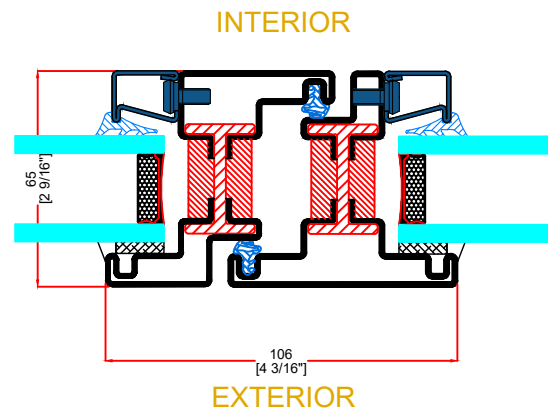

**2** TYPICAL JAMB  
EXTERIOR FLANGE

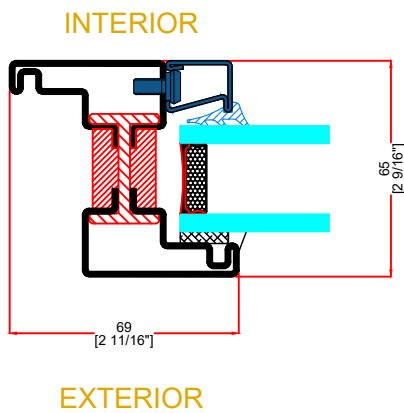

**3** TYPICAL FIXED  
INTERIOR FLANGE

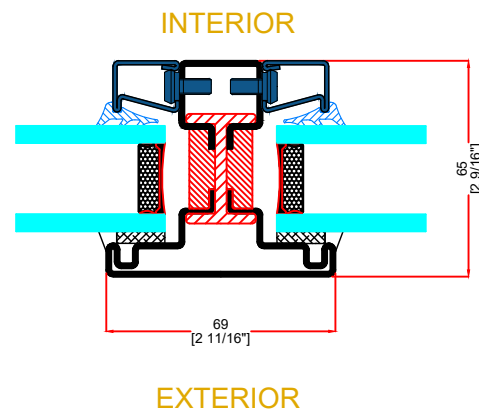

**4** TYPICAL FIXED  
EXTERIOR FLANGE



## GLAZING BEADS

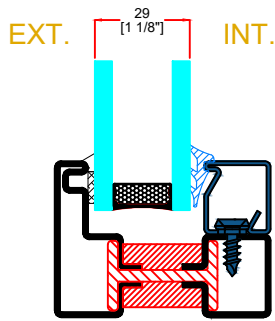

GB-1007  
GLAZING BEAD

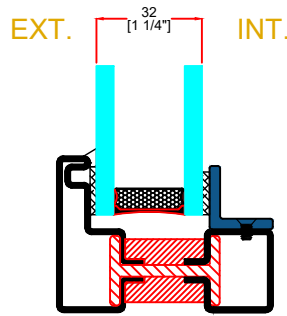

GB18-.75  
GLAZING BEAD

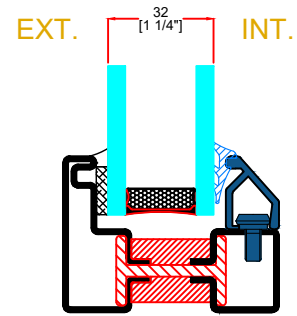

GB-1015  
GLAZING BEAD

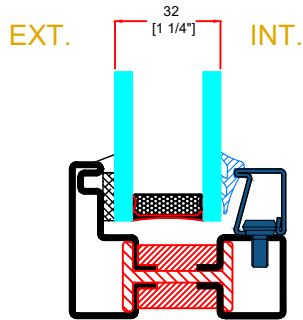

GB-2007  
GLAZING BEAD

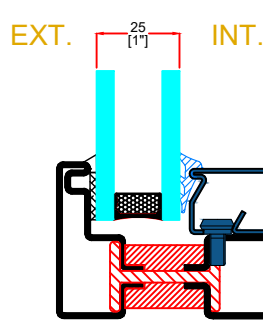

GB-2008  
GLAZING BEAD