

PROJECT-IN WINDOW

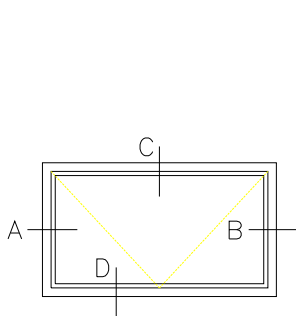

HR4511-PI

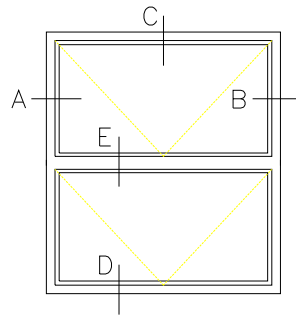

HR4512-PI-PI

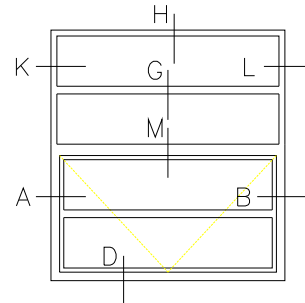

HR4514-PI-FX

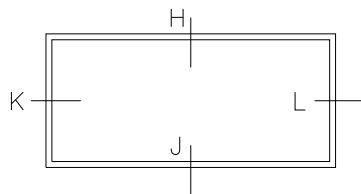

HR4511-FX

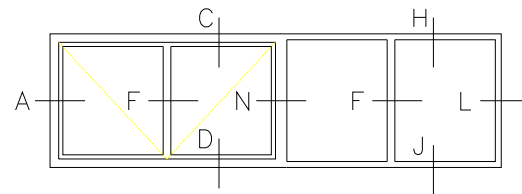

HR4541-PI-FX

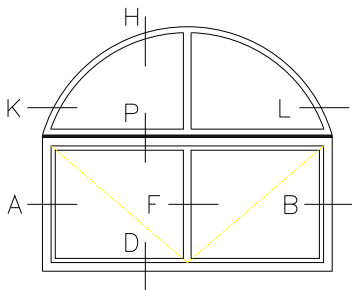

HR4522-PI-FX ARCH

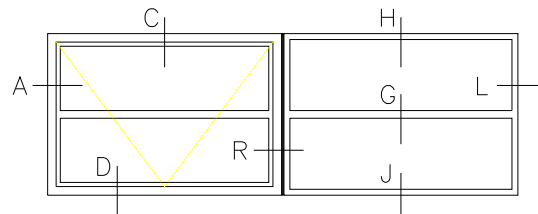

HR4522-PI-FX

PROJECT-IN WINDOW

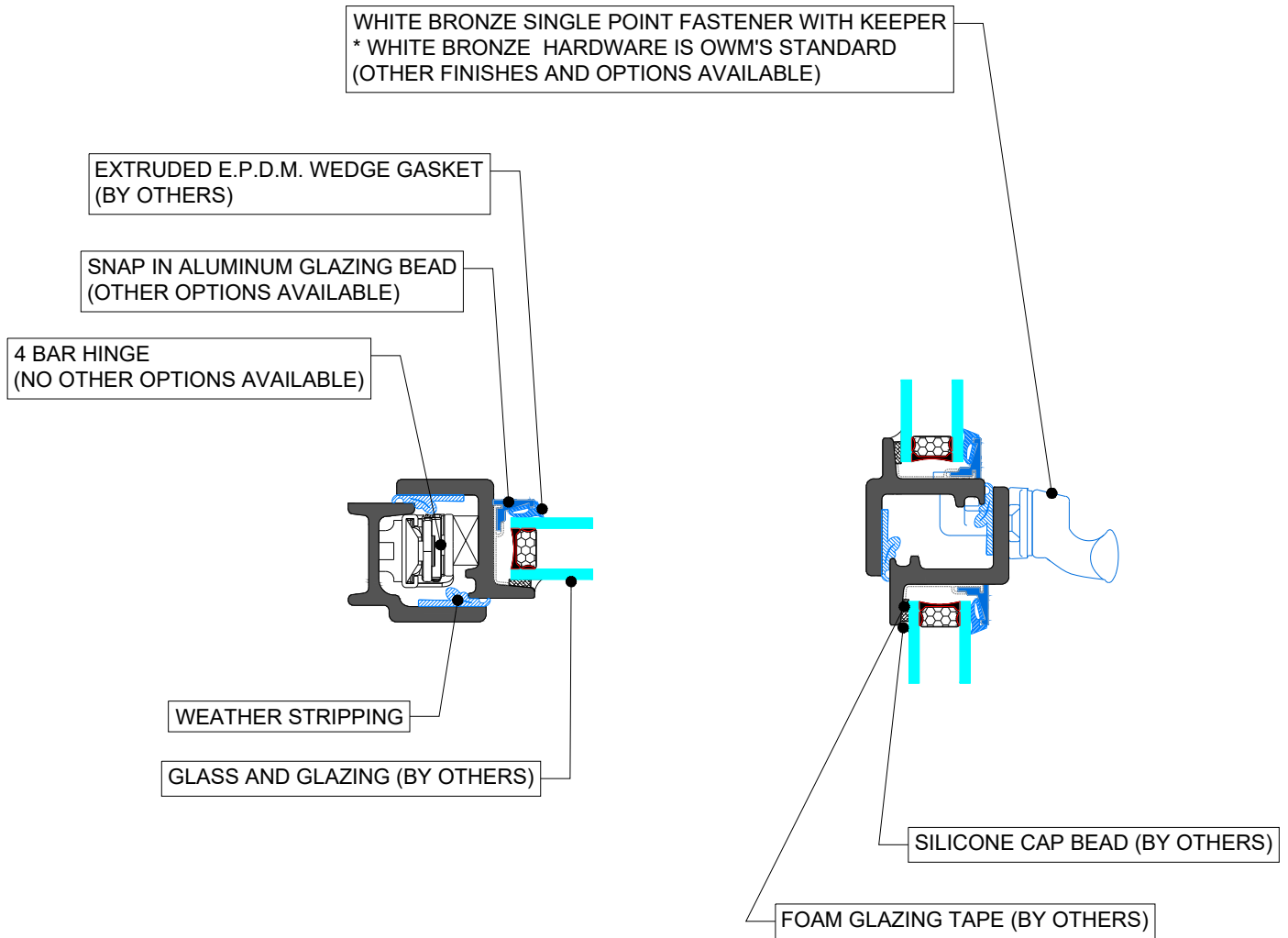

PROJECT-IN WINDOW

INTERIOR

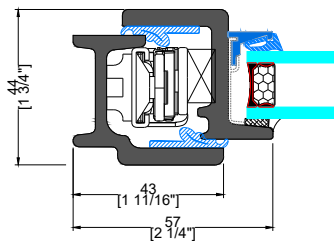

EXTERIOR

A&B TYPICAL HINGED JAMB

EXTERIOR

INTERIOR

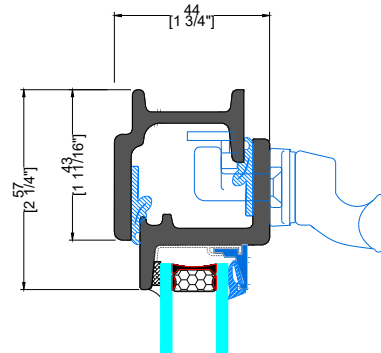

C TYPICAL HEAD

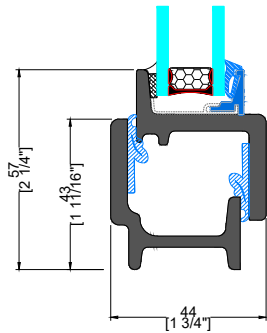

EXTERIOR

INTERIOR

D TYPICAL SILL

EXTERIOR

INTERIOR

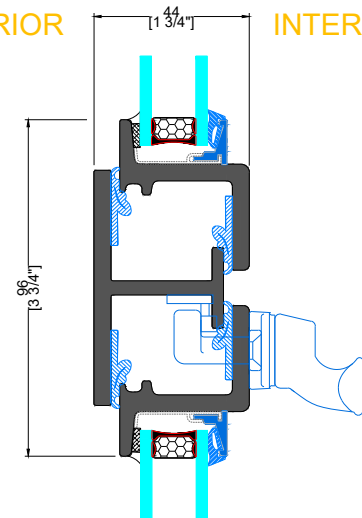

E TYPICAL STACKING MULLION

PROJECT-IN WINDOW

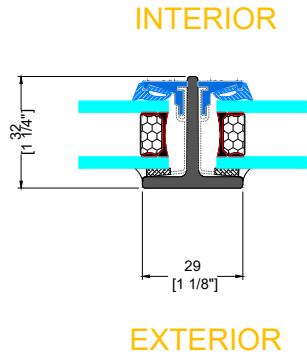

F TYPICAL VERTICAL MUNTIN

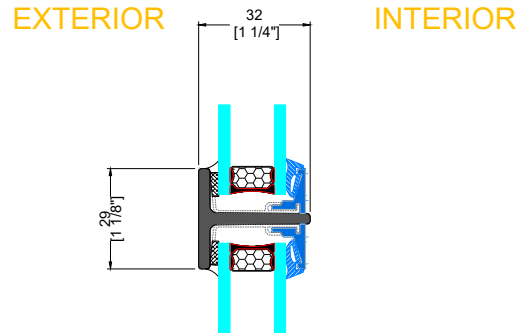

G TYPICAL HORIZONTAL MUNTIN

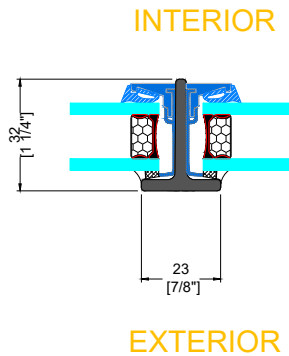

F SMALL VERTICAL MUNTIN

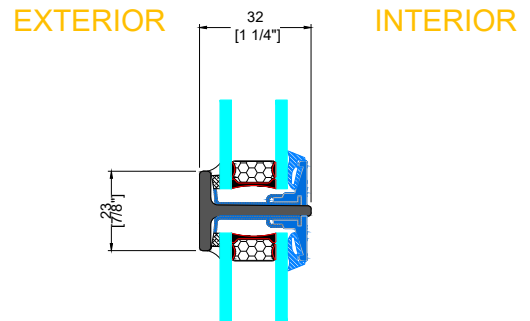

G SMALL HORIZONTAL MUNTIN

PROJECT-IN WINDOW

EXTERIOR INTERIOR

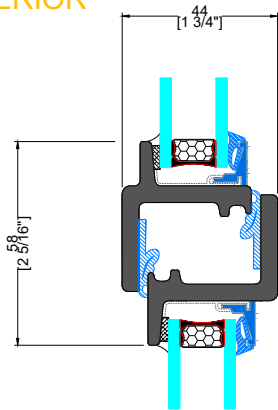

M TYPICAL HEAD W/ TRANSOM

INTERIOR

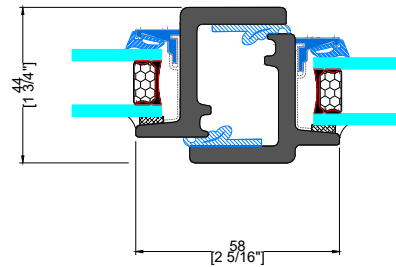

N TYPICAL JAMB W/ SIDELITE

EXTERIOR INTERIOR

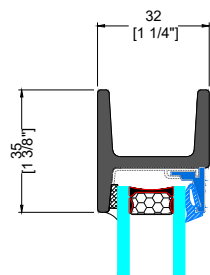

H&J TYPICAL FIXED HEAD & SILL

INTERIOR

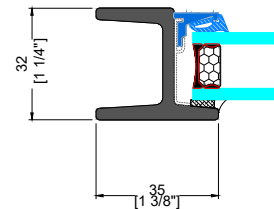

K&L TYPICAL FIXED JAMB

PROJECT-IN WINDOW

INTERIOR

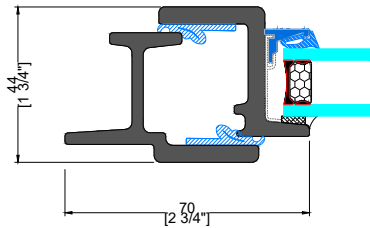

EXTERIOR

1 TYPICAL JAMB EXTERIOR FLANGE

INTERIOR

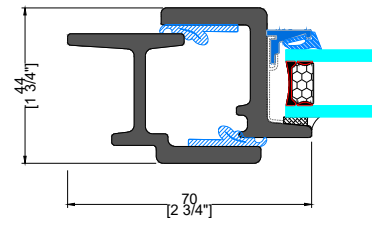

EXTERIOR

2 TYPICAL JAMB INTERIOR FLANGE

INTERIOR

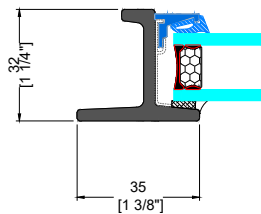

EXTERIOR

3 TYPICAL FIXED EXTERIOR FLANGE

INTERIOR

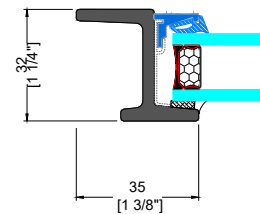

EXTERIOR

4 TYPICAL FIXED INTERIOR FLANGE

GLAZING BEADS

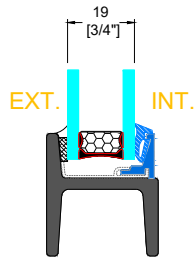

GB-05
GLAZING BEAD

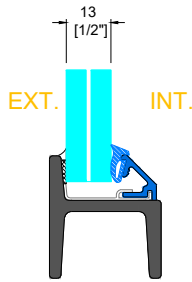

GB-04
GLAZING BEAD

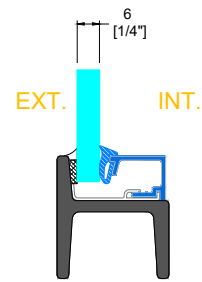

GB-06
GLAZING BEAD

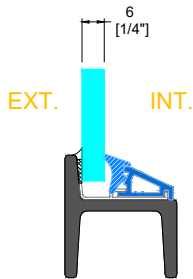

GB-16
GLAZING BEAD

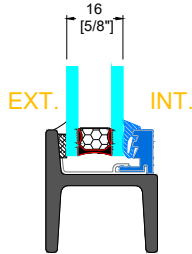

GB-13
GLAZING BEAD

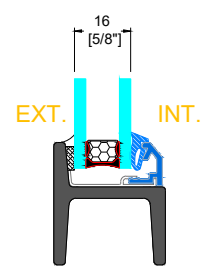

GB-12
GLAZING BEAD

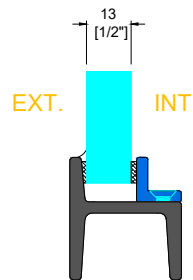

GB-18X
GLAZING BEAD