

INSWING DOOR

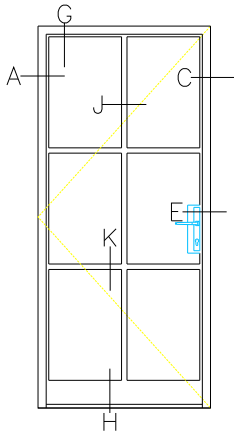

HR4723-ID

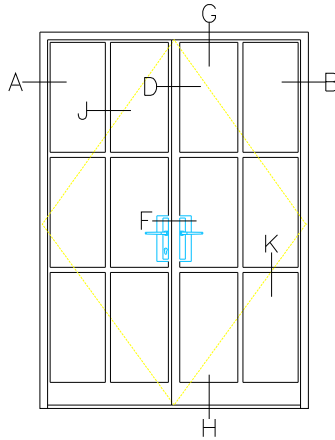

HR4743-FR-ID

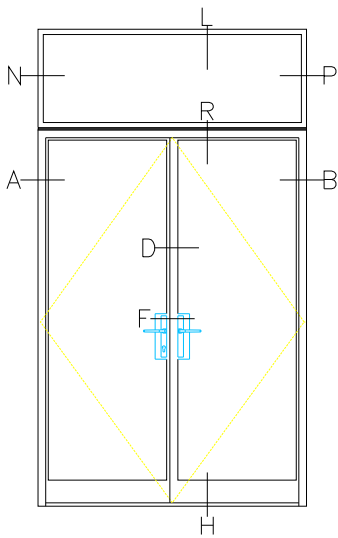

HR4722-FR-ID-FX

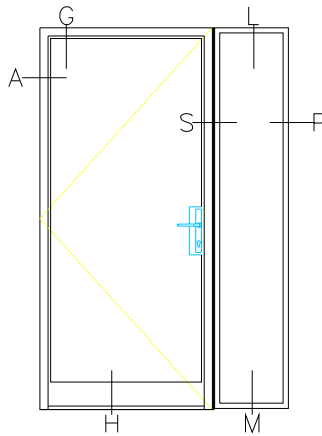

HR4721-ID-FX

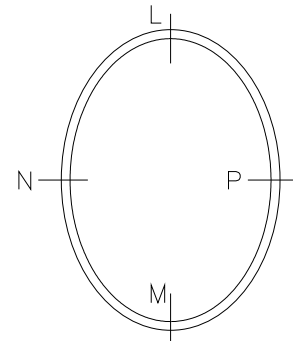

HR4711-FX OVAL

IN SWING DOOR

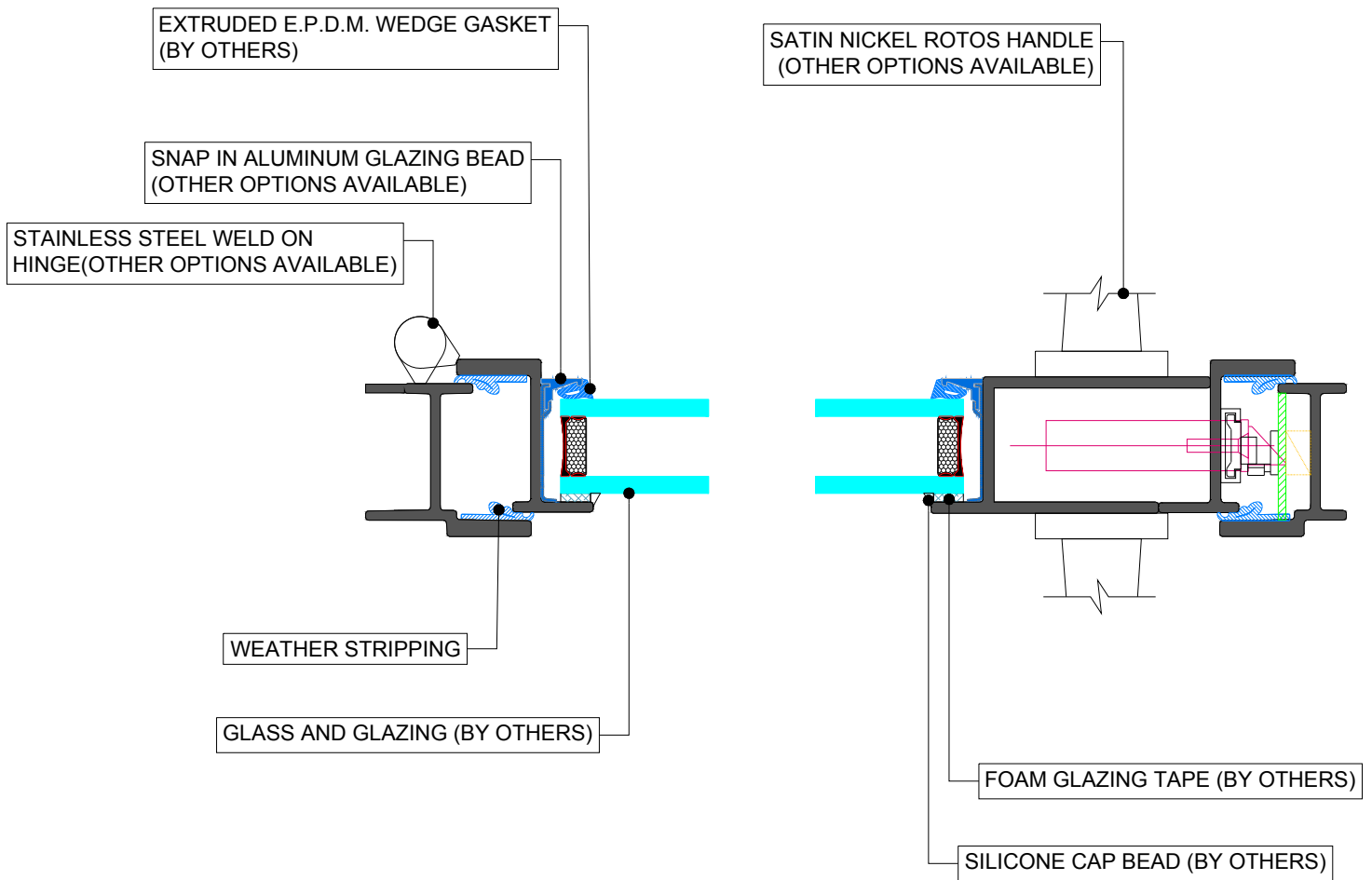

INSWING DOOR

INTERIOR

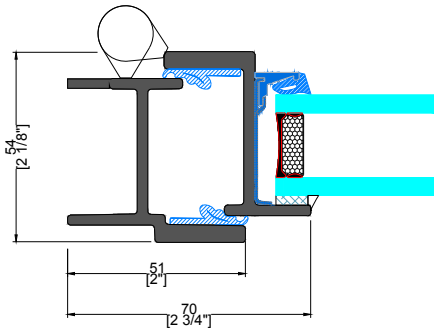

EXTERIOR

A&B TYPICAL HINGED JAMB

INTERIOR

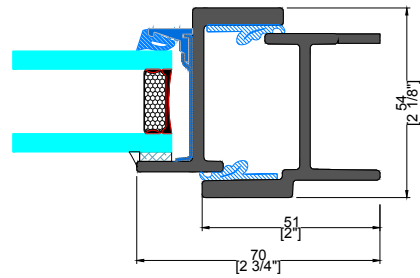

EXTERIOR

C TYPICAL LOCKING JAMB

INTERIOR

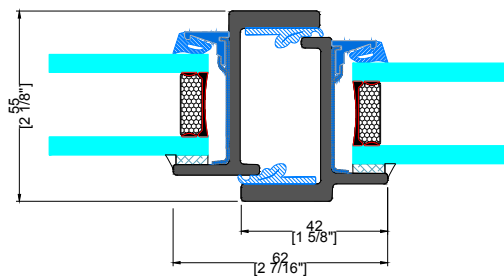

EXTERIOR

D TYPICAL FRENCH MEETING RAIL

INSWING DOOR

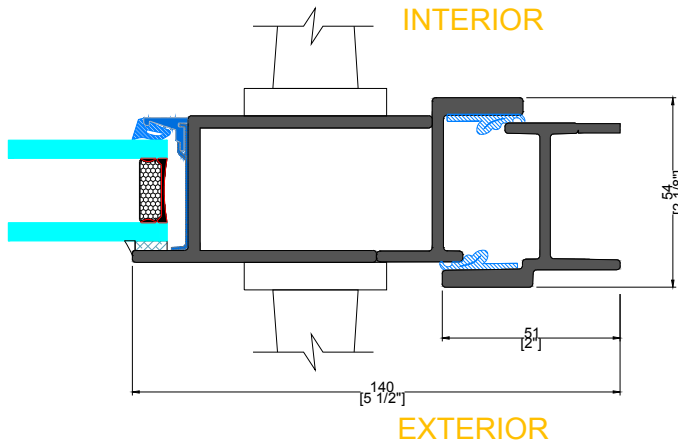

E TYPICAL LOCKBOX
SINGLE DOOR

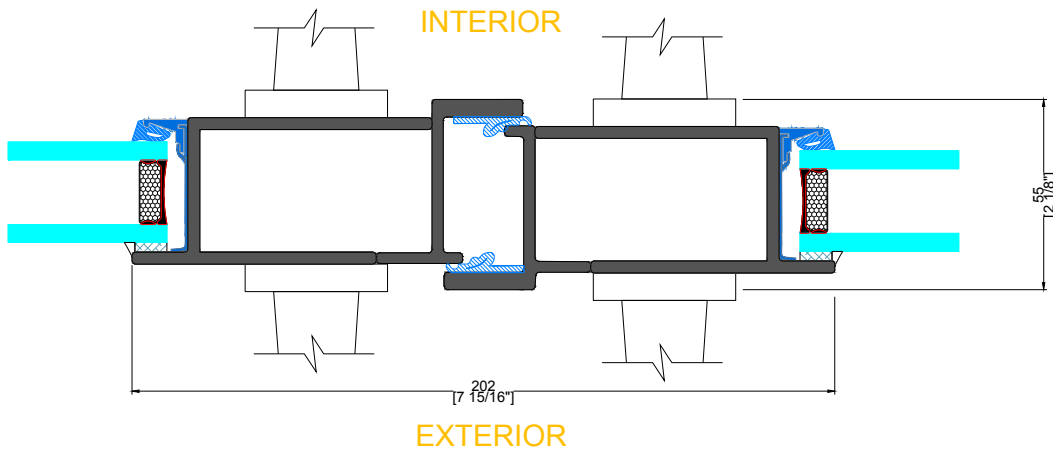

F TYPICAL LOCKBOX
FRENCH DOOR

INSWING DOOR

EXTERIOR

INTERIOR

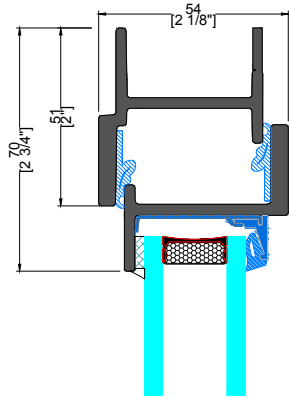

G TYPICAL HEAD

EXTERIOR

INTERIOR

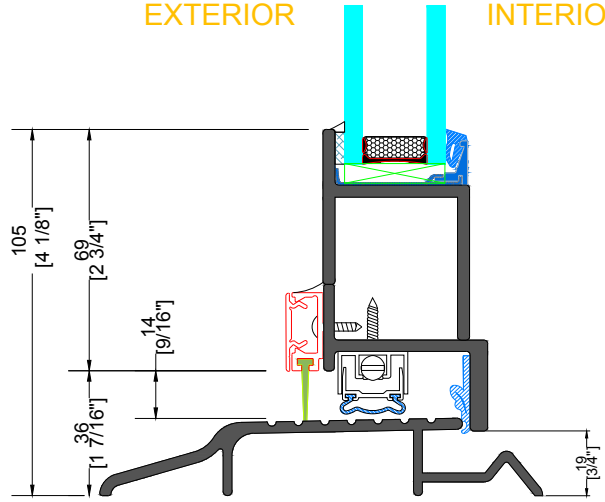

H TYPICAL KICKPLATE

EXTERIOR

INTERIOR

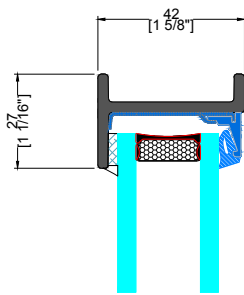

L&M TYPICAL FIXED HEAD & SILL

INTERIOR

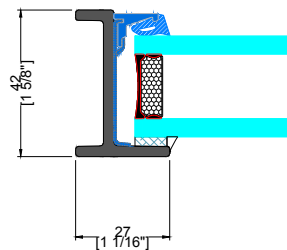

EXTERIOR

N&P TYPICAL FIXED JAMB

INSWING DOOR

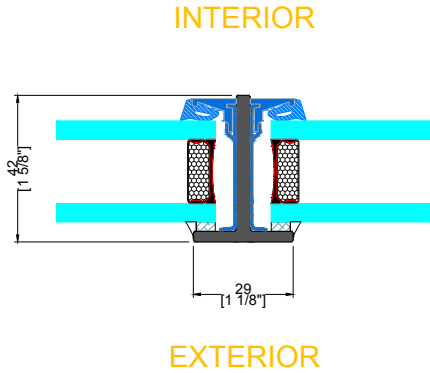

J SMALL VERTICAL MUNTIN

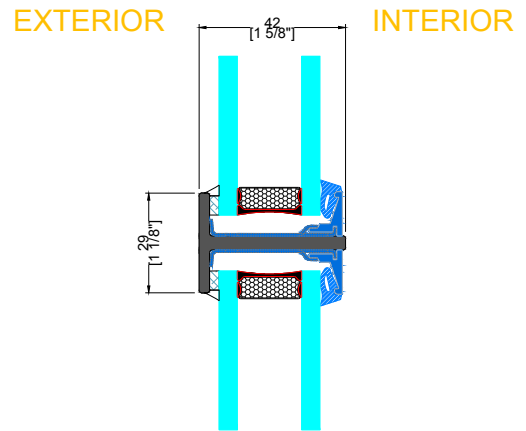

K SMALL HORIZONTAL MUNTIN

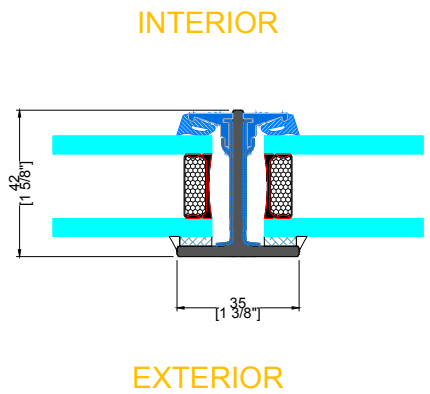

J TYPICAL VERTICAL MUNTIN

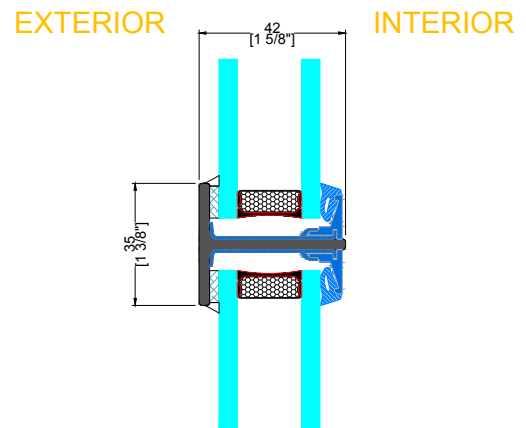

K TYPICAL HORIZONTAL MUNTIN

IN SWING DOOR

INTERIOR

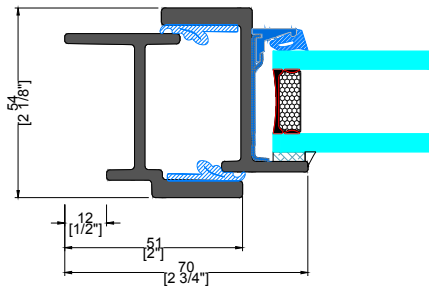

EXTERIOR

1 TYPICAL
INTERIOR FLANGE

INTERIOR

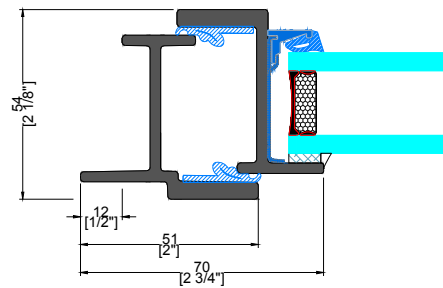

EXTERIOR

2 TYPICAL
EXTERIOR FLANGE

INTERIOR

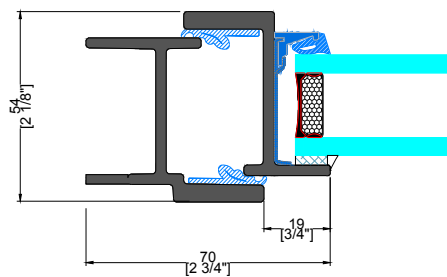

EXTERIOR

1 TYPICAL
LONG LEG

GLAZING BEADS

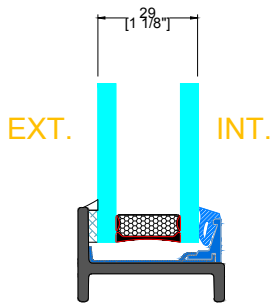

GB-05X
GLAZING BEAD

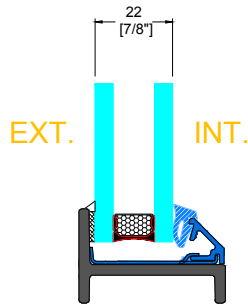

GB-04X
GLAZING BEAD

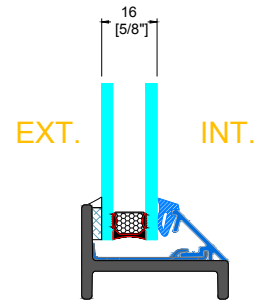

GB-15X
GLAZING BEAD

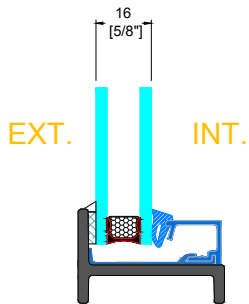

GB-06X
GLAZING BEAD

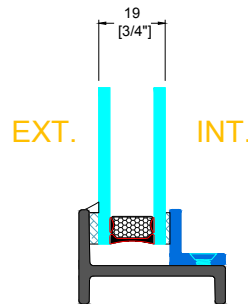

1/2" x 3/4"
STEEL GLAZING BEAD

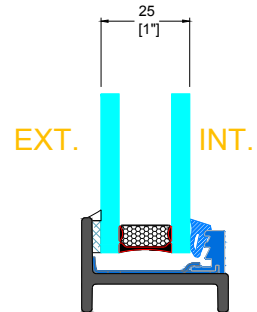

GB-13X ALUMINUM
GLAZING BEAD

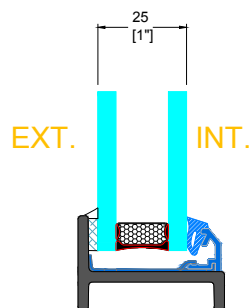

GB-12X ALUMINUM
GLAZING BEAD

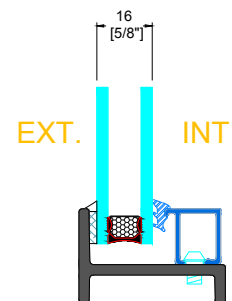

GB-31
GLAZING BEAD

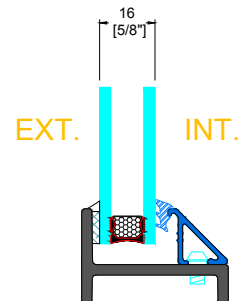

GB-35
GLAZING BEAD