

PROJECT-IN WINDOW

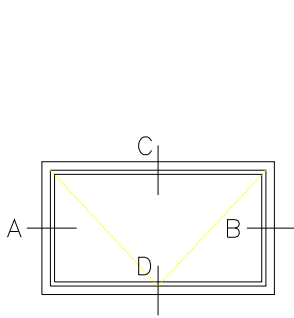

HR4711-PI

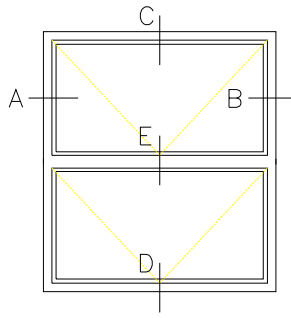

HR4712-PI-PI

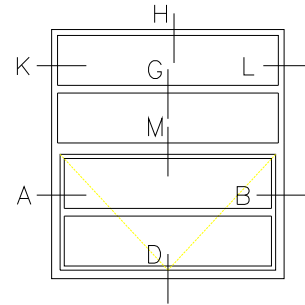

HR4714-PI-FX

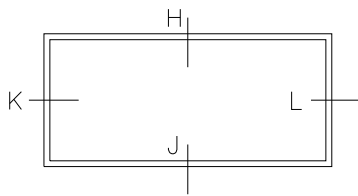

HR4711-FX

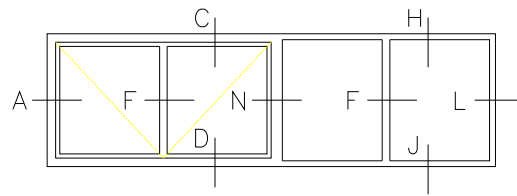

HR4741-PI-FX

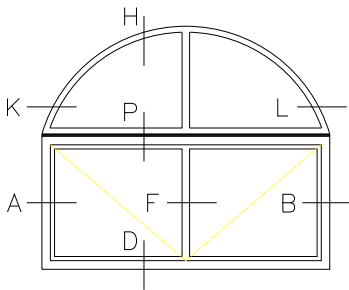

HR4722-PI-FX ARCH

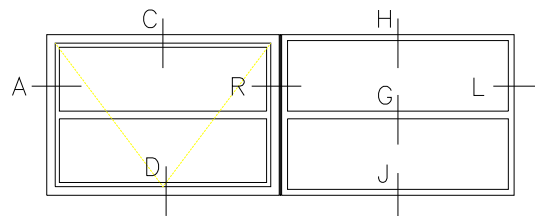

HR4722-PI-FX

PROJECT-IN WINDOW

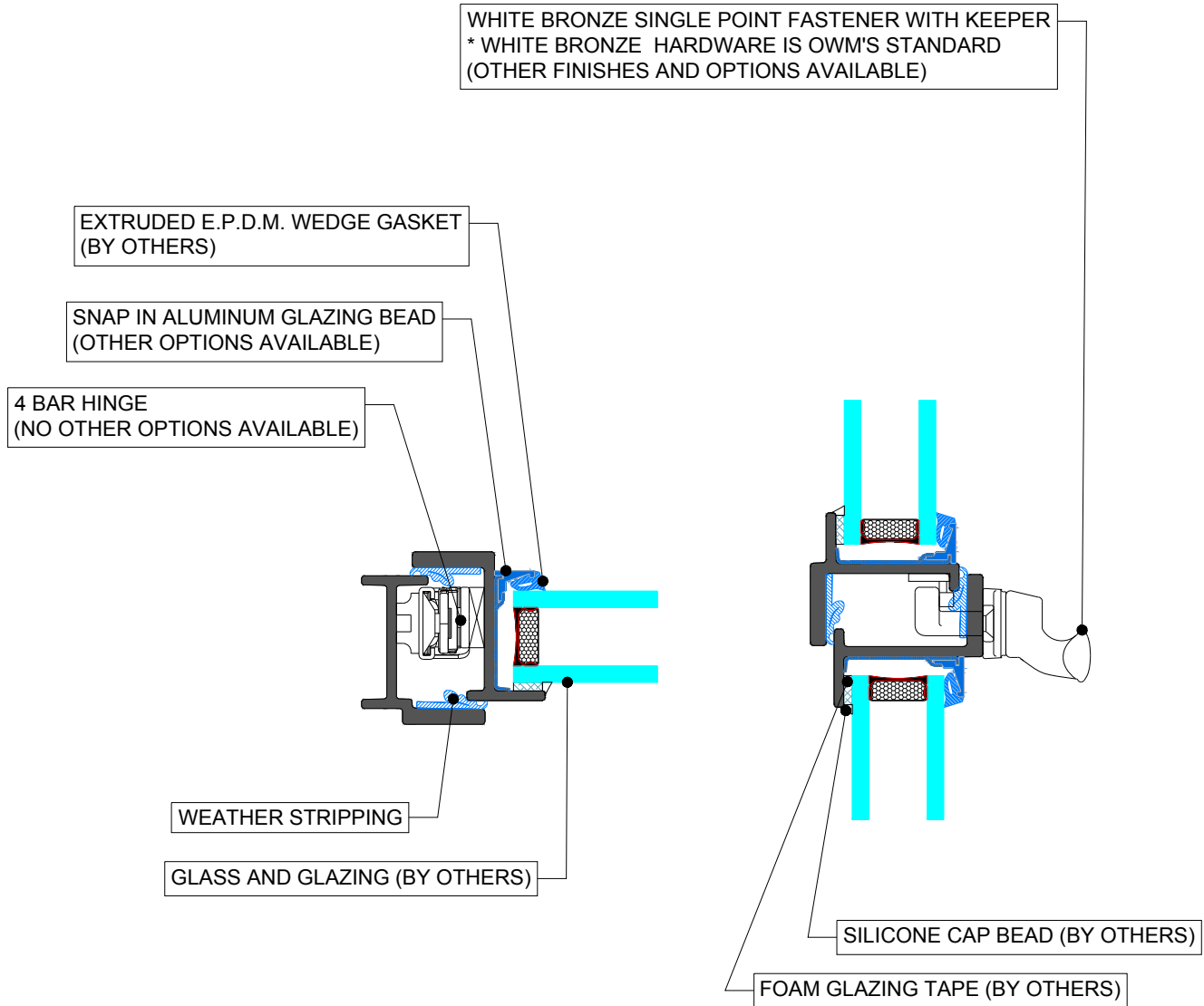

PROJECT-IN WINDOW

INTERIOR

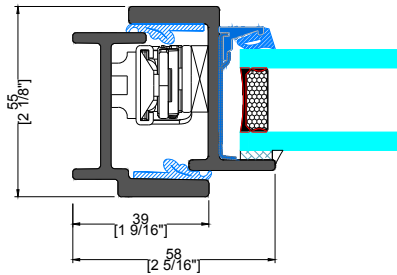

EXTERIOR

A&B TYPICAL HINGED JAMB

EXTERIOR

INTERIOR

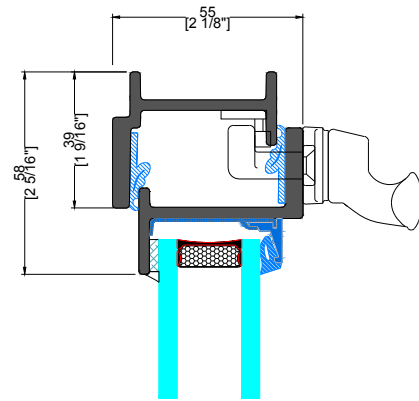

C TYPICAL LOCKING HEAD

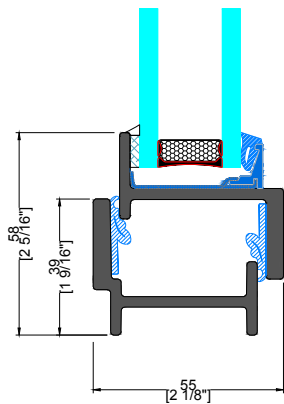

EXTERIOR

INTERIOR

D TYPICAL SILL

EXTERIOR

INTERIOR

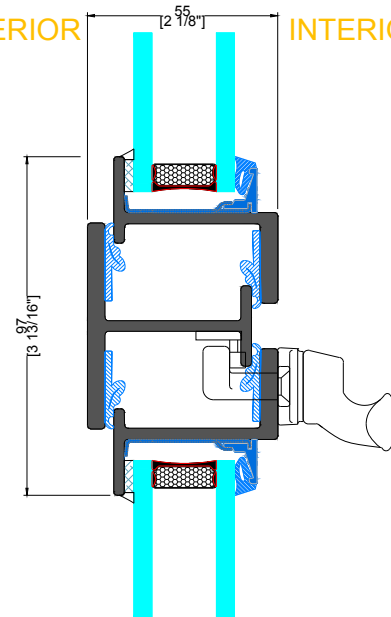

E TYPICAL STACKING JOINT

PROJECT-IN WINDOW

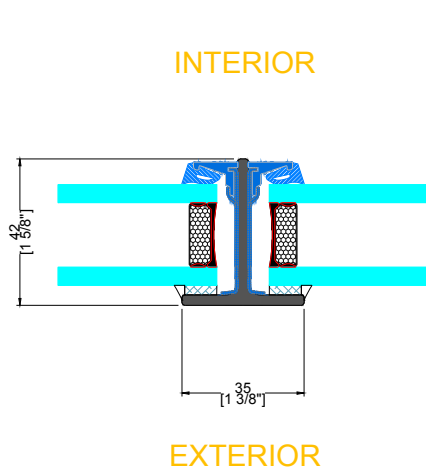

F TYPICAL VERTICAL MUNTIN

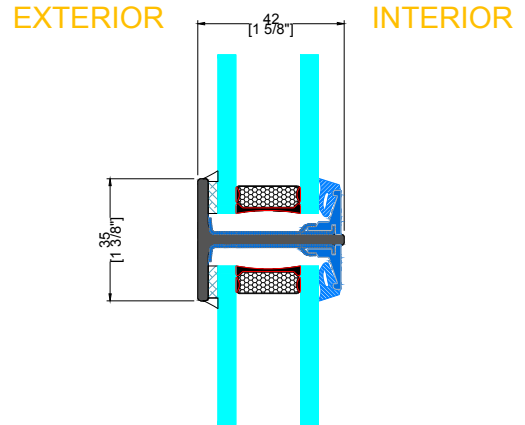

G TYPICAL HORIZONTAL MUNTIN

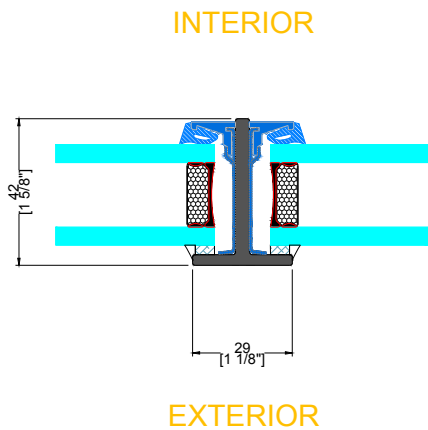

F SMALL VERTICAL MUNTIN

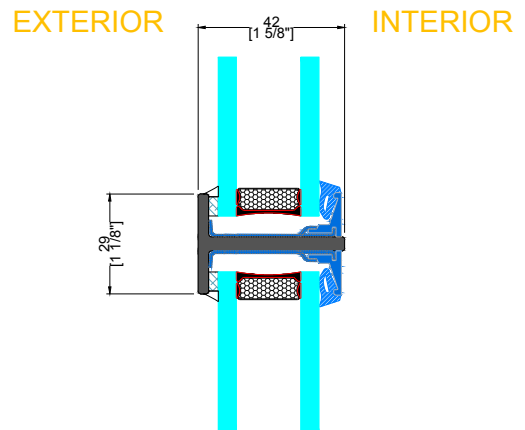

G SMALL HORIZONTAL MUNTIN

PROJECT-IN WINDOW

EXTERIOR

INTERIOR

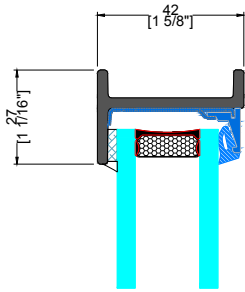

H&J TYPICAL FIXED HEAD & SILL

INTERIOR

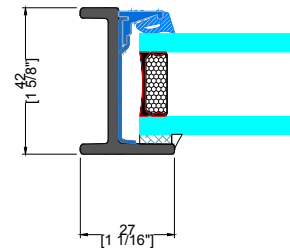

K&L TYPICAL FIXED JAMB

EXTERIOR

INTERIOR

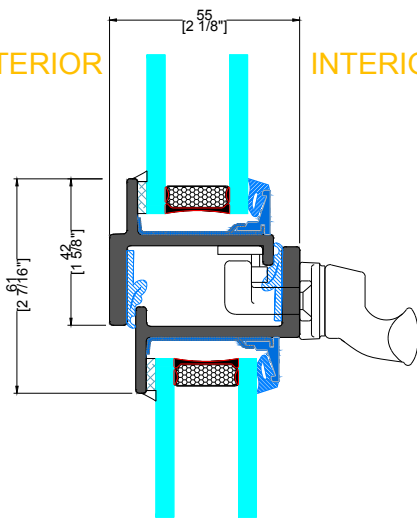

M TYPICAL HEAD W/ TRANSOM

INTERIOR

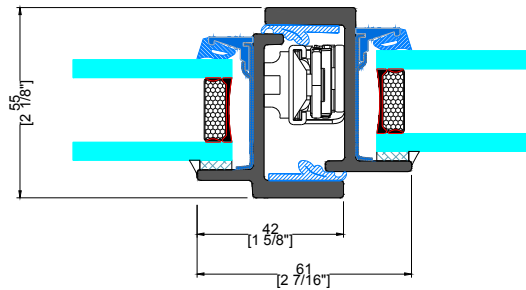

N TYPICAL JAMB W/ SIDELITE

PROJECT-IN WINDOW

INTERIOR

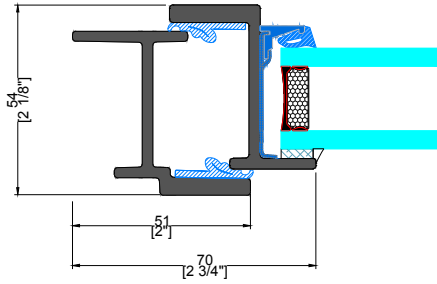

EXTERIOR

1 TYPICAL INTERIOR FLANGE

INTERIOR

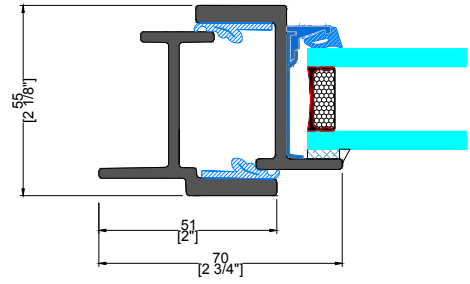

EXTERIOR

2 TYPICAL EXTERIOR FLANGE

INTERIOR

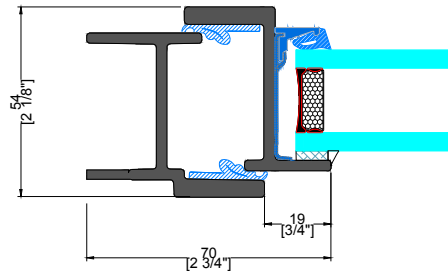

EXTERIOR

1 TYPICAL LONG LEG

GLAZING BEADS

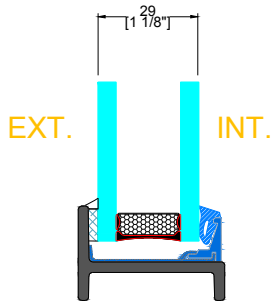

GB-05X
GLAZING BEAD

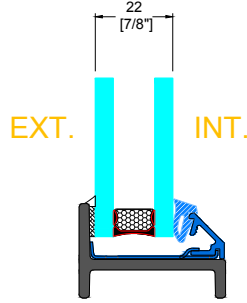

GB-04X
GLAZING BEAD

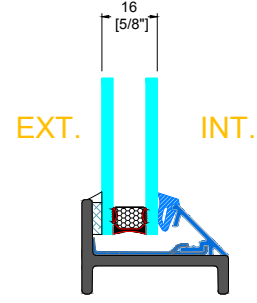

GB-15X
GLAZING BEAD

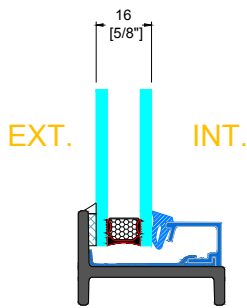

GB-06X
GLAZING BEAD

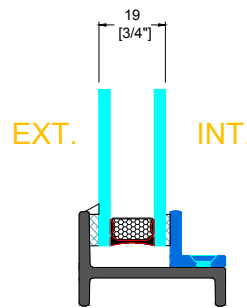

1/2" x 3/4"
STEEL GLAZING BEAD

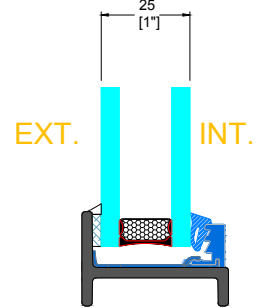

GB-13X ALUMINUM
GLAZING BEAD

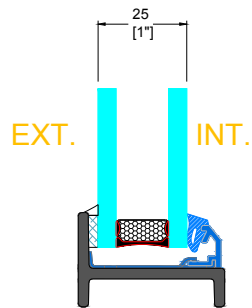

GB-12X ALUMINUM
GLAZING BEAD

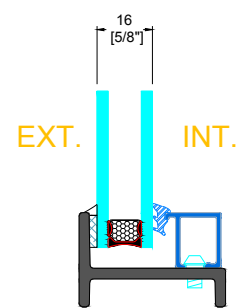

GB-31
GLAZING BEAD

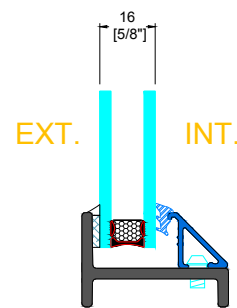

GB-35
GLAZING BEAD