

PROJECT-OUT WINDOW

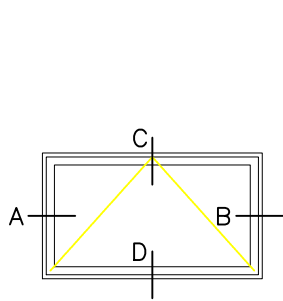

HR4711-PO

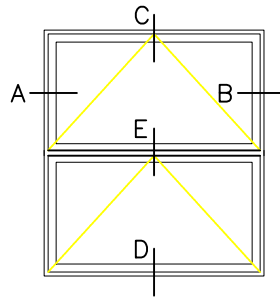

HR4712-PO-PO

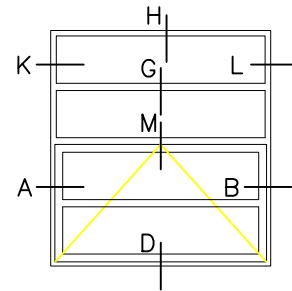

HR4714-PO-FX

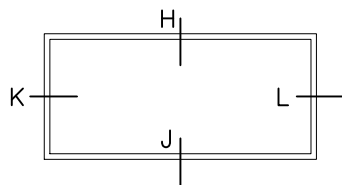

HR4711-FX

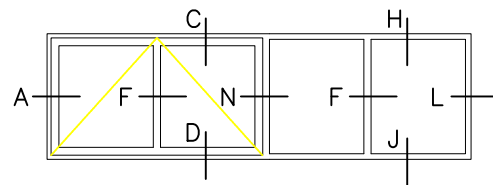

HR4741-PO-FX

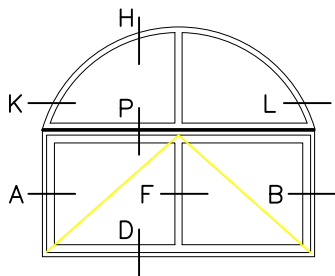

HR4722-PO-FX ARCH

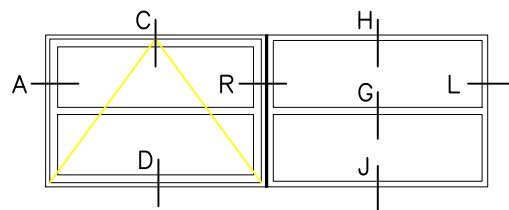

HR4722-PO-FX

PROJECT-OUT WINDOW

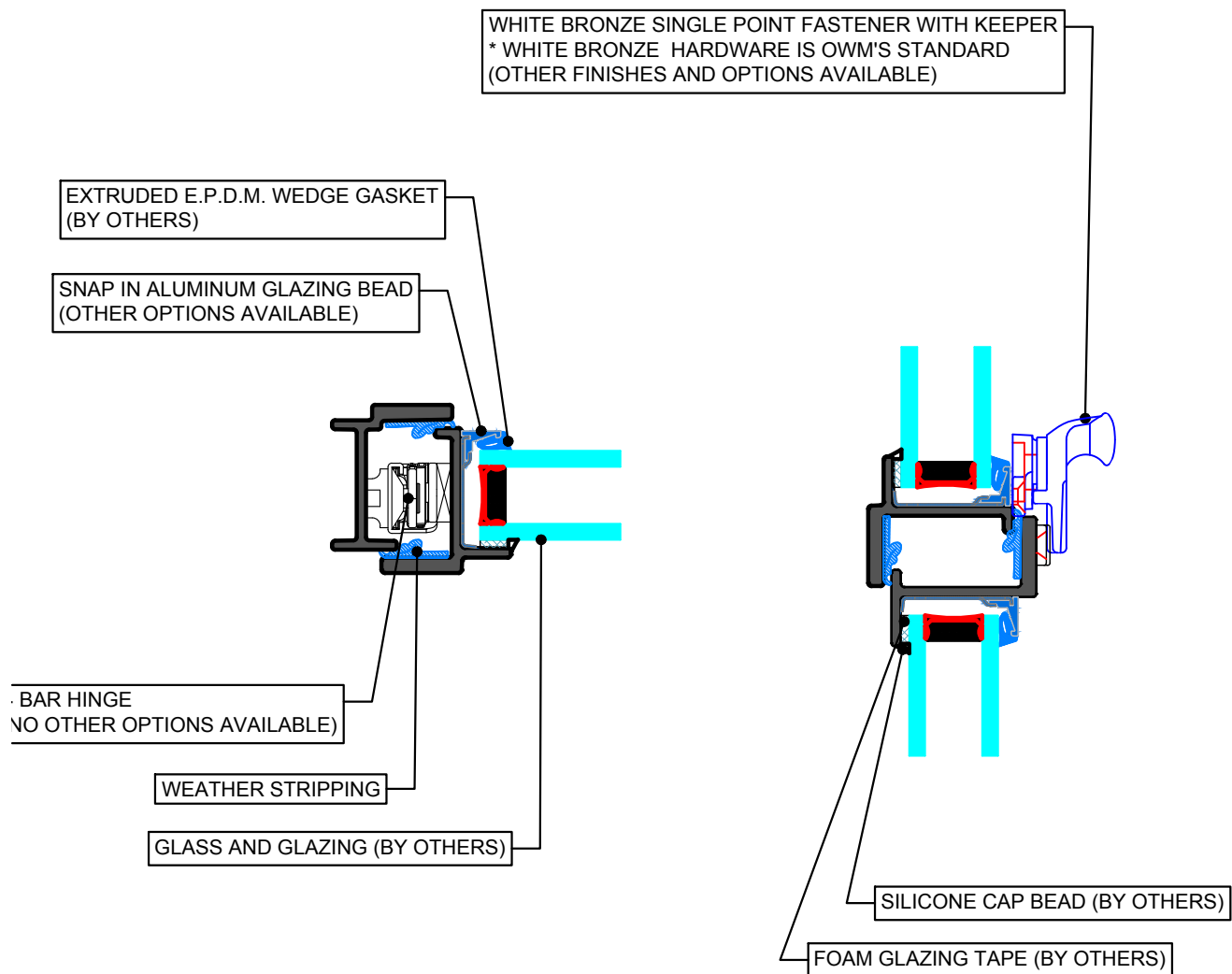

PROJECT-OUT WINDOW

INTERIOR

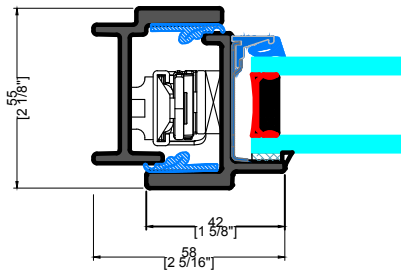

EXTERIOR

A&B TYPICAL HINGED JAMB

EXTERIOR

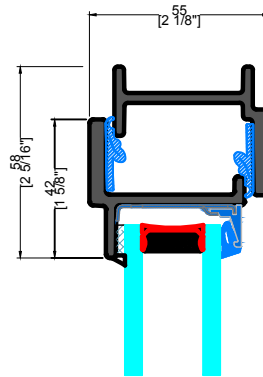

INTERIOR

C TYPICAL HEAD

EXTERIOR

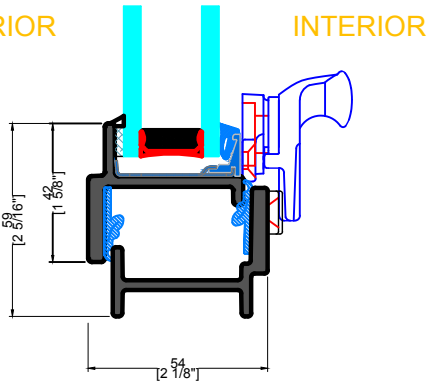

INTERIOR

D TYPICAL SILL

EXTERIOR

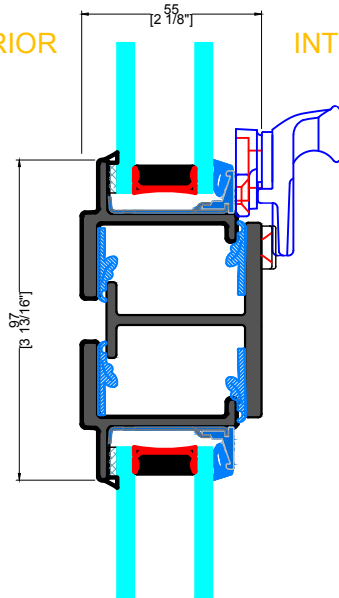

INTERIOR

E TYPICAL STACKING JOINT

PROJECT-OUT WINDOW

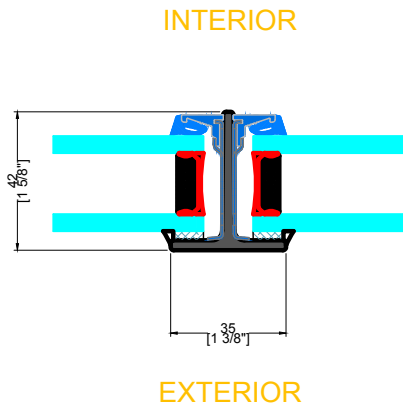

F TYPICAL VERTICAL MUNTIN

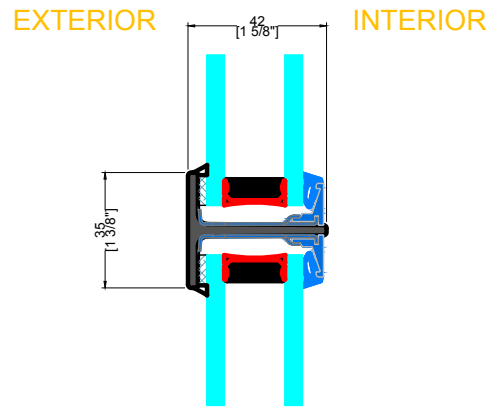

G TYPICAL HORIZONTAL MUNTIN

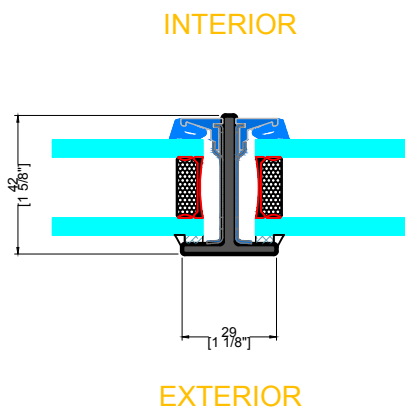

F TYPICAL VERTICAL MUNTIN

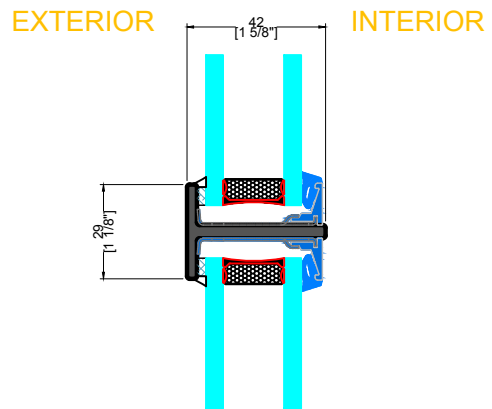

G TYPICAL HORIZONTAL MUNTIN

PROJECT-OUT WINDOW

EXTERIOR

INTERIOR

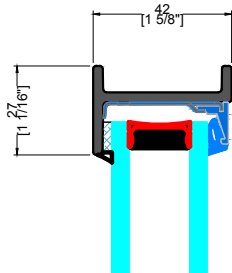

H&J TYPICAL FIXED HEAD & SILL

INTERIOR

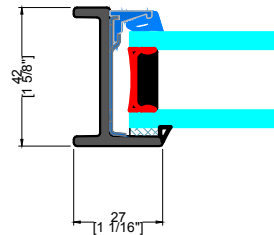

K&L TYPICAL FIXED JAMB

EXTERIOR

INTERIOR

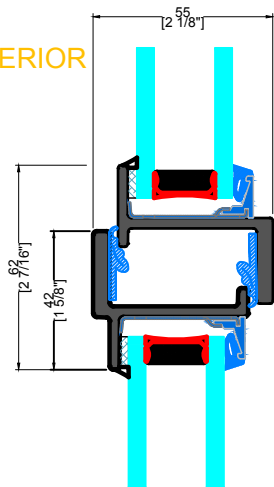

M TYPICAL HEAD W/ TRANSOM

INTERIOR

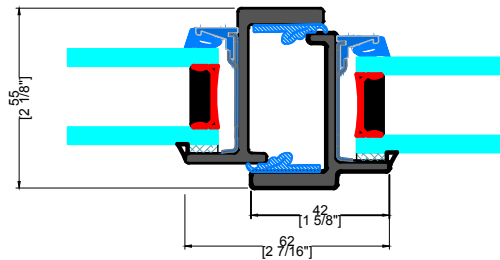

N TYPICAL JAMB W/ SIDELITE

PROJECT-OUT WINDOW

INTERIOR

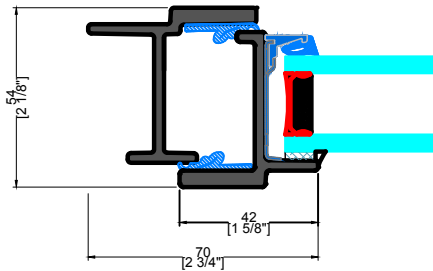

EXTERIOR

1 TYPICAL INTERIOR FLANGE

INTERIOR

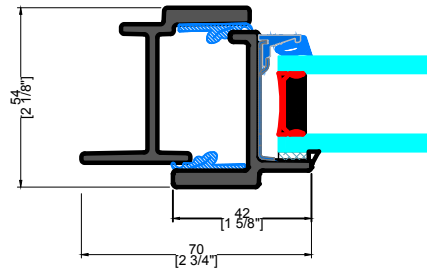

EXTERIOR

2 TYPICAL EXTERIOR FLANGE

INTERIOR

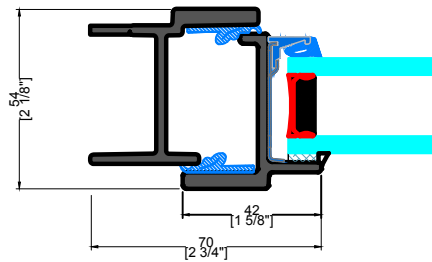

EXTERIOR

3 TYPICAL LONG LEG

GLAZING BEADS

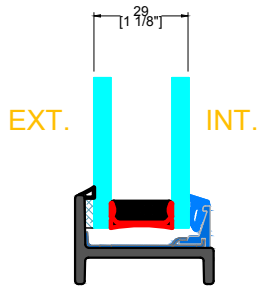

GB-05X
GLAZING BEAD

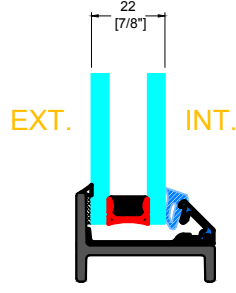

GB-04X
GLAZING BEAD

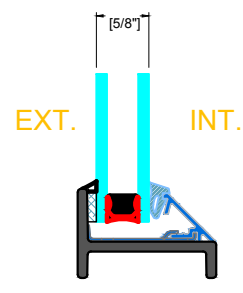

GB-15X
GLAZING BEAD

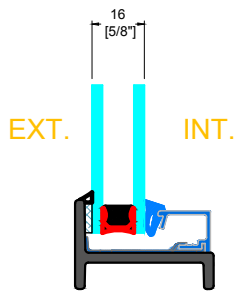

GB-06X
GLAZING BEAD

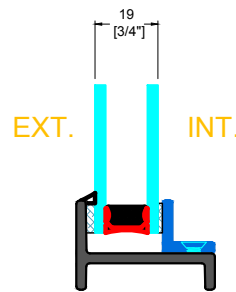

1/2" x 3/4"
STEEL GLAZING BEAD

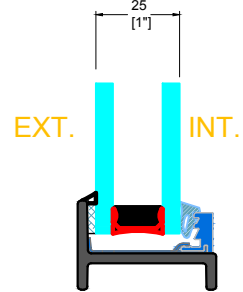

GB-13X
GLAZING BEAD

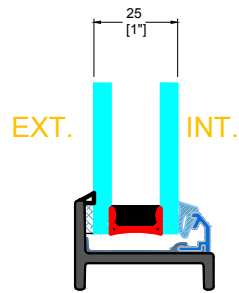

GB-12X
GLAZING BEAD

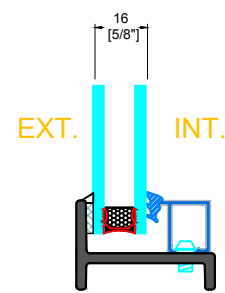

GB-31
GLAZING BEAD

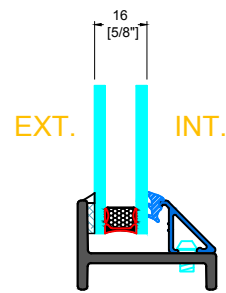

GB-35
GLAZING BEAD