

PROJECT-IN WINDOW

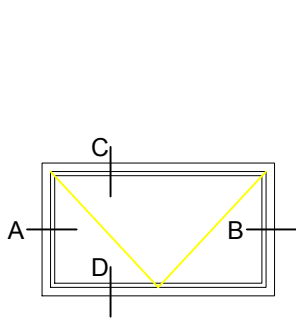

RTS4311-PI

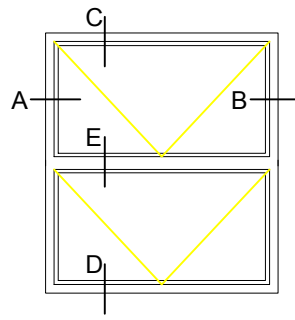

RTS4312-PI-PI

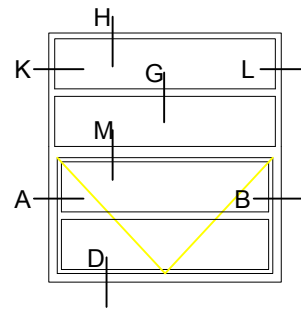

RTS4314-PI-FX

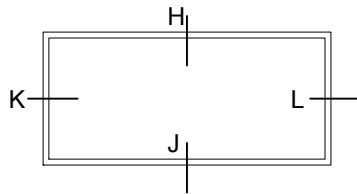

RTS4311-FX

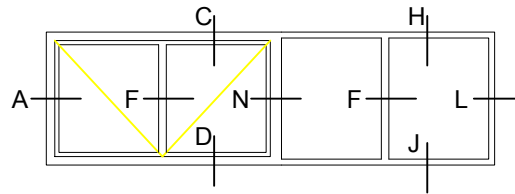

RTS4341-PI-FX

PROJECT-IN WINDOW

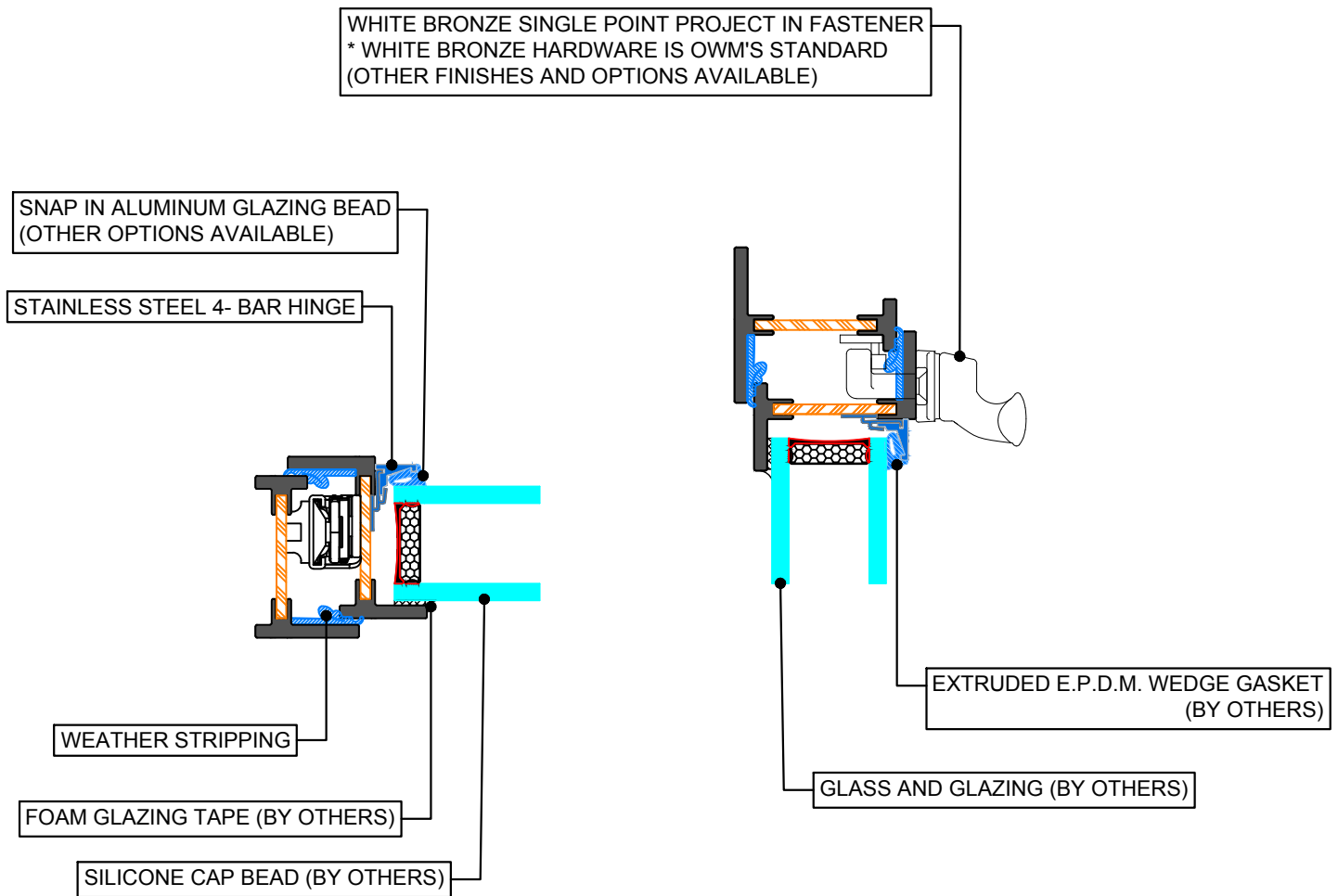

PROJECT-IN WINDOW

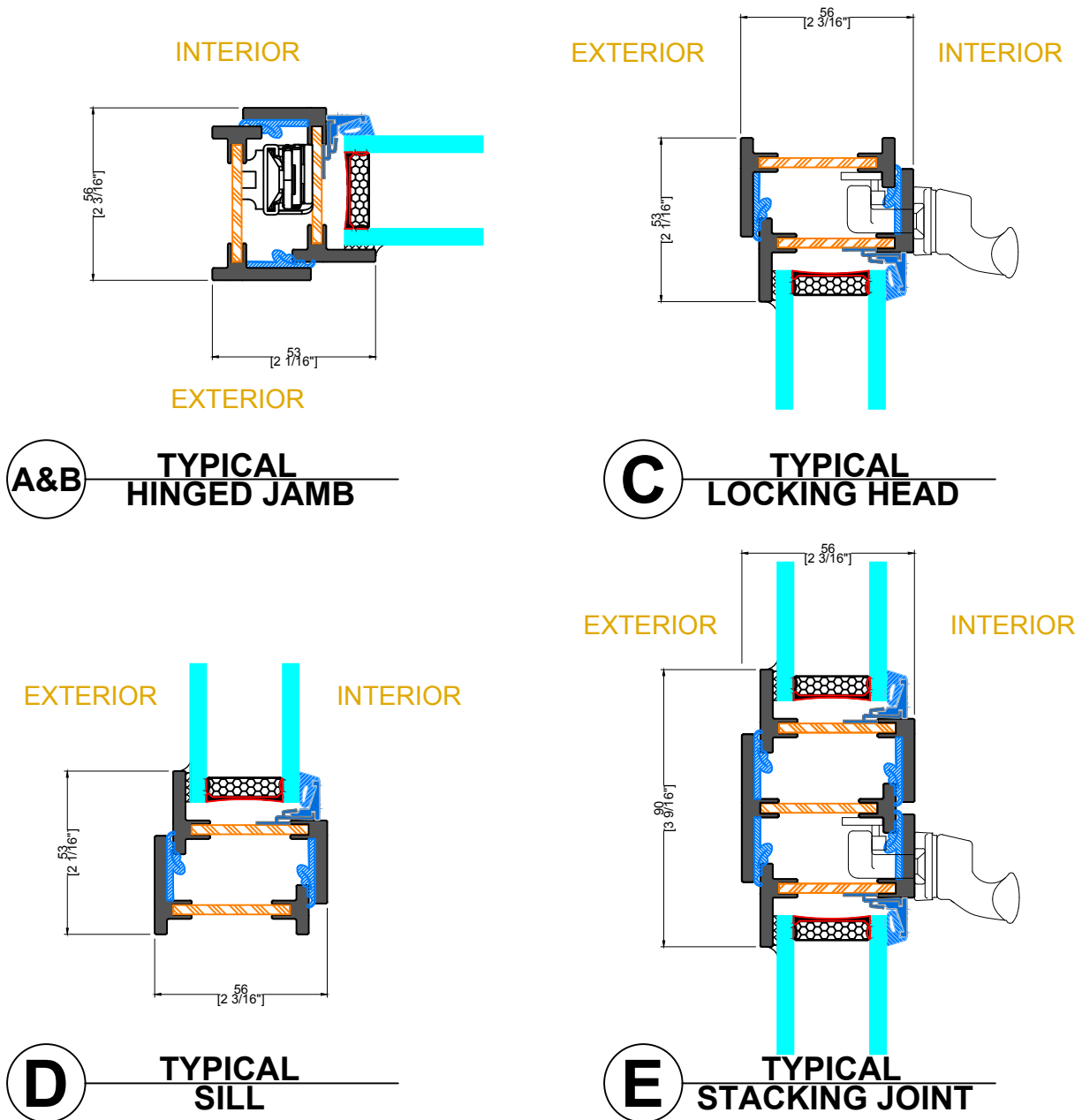

PROJECT-IN WINDOW

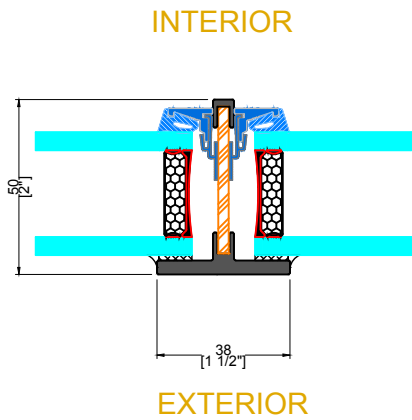

F TYPICAL VERTICAL MUNTIN

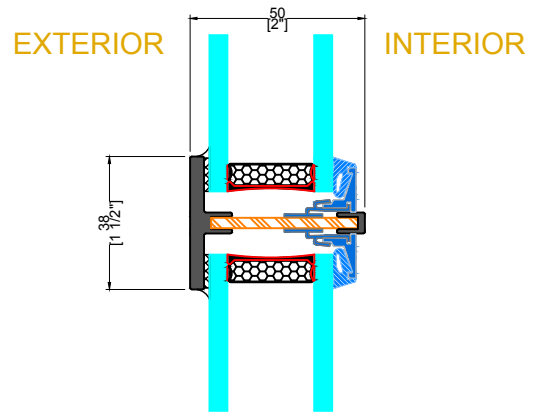

G TYPICAL HORIZONTAL MUNTIN

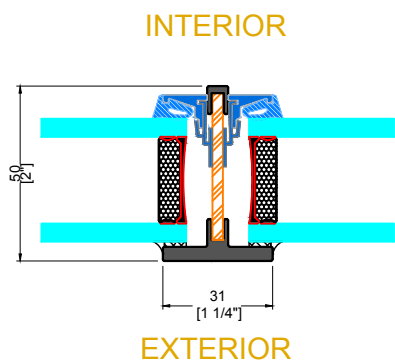

F TYPICAL VERTICAL MUNTIN

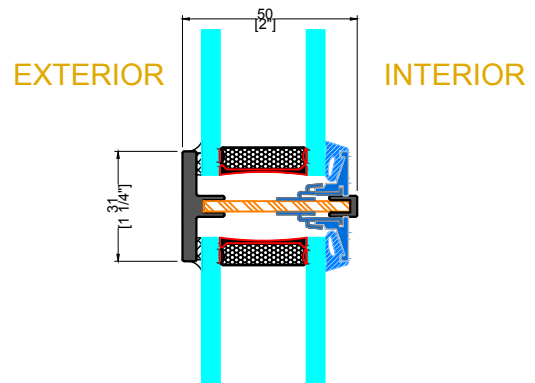

G TYPICAL HORIZONTAL MUNTIN

PROJECT-IN WINDOW

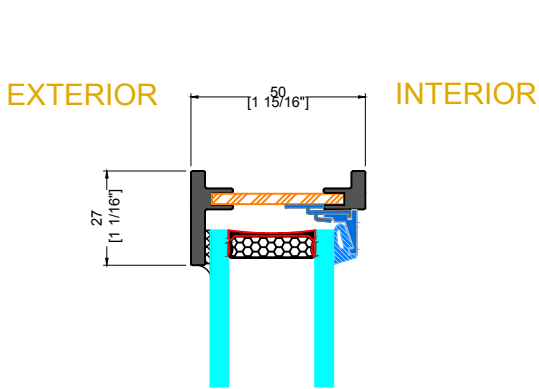

H&J TYPICAL FIXED HEAD & SILL

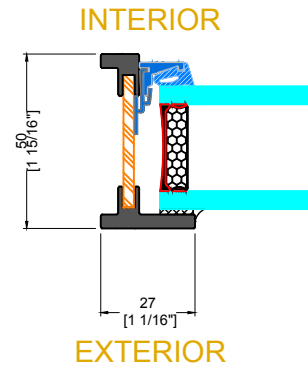

K&L TYPICAL FIXED JAMB

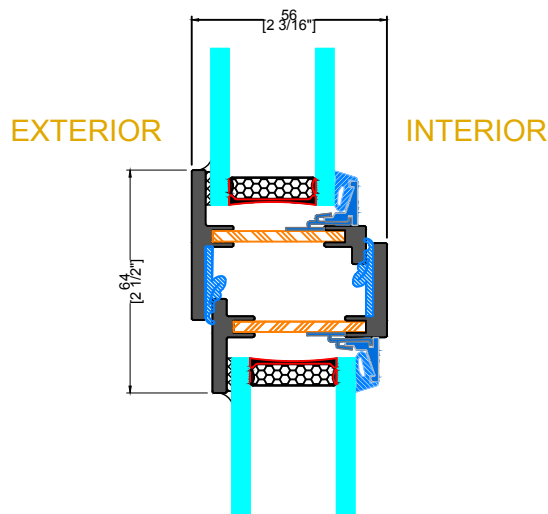

M TYPICAL HEAD W/ TRANSOM

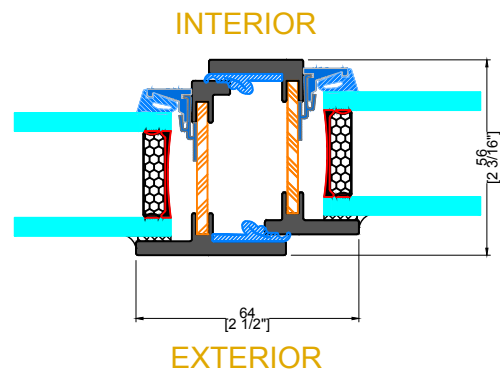

N TYPICAL JAMB W/ SIDELITE

PROJECT-IN WINDOW

INTERIOR

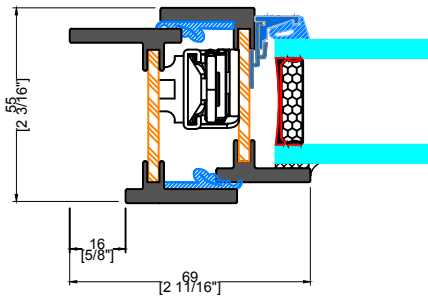

EXTERIOR

1 TYPICAL JAMB INTERIOR FLANGE

INTERIOR

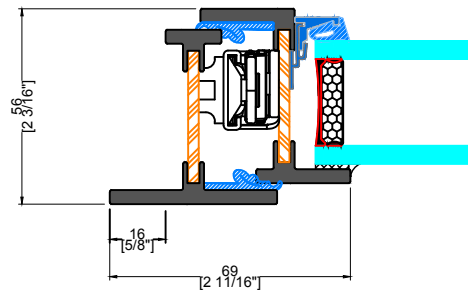

EXTERIOR

2 TYPICAL JAMB EXTERIOR FLANGE

INTERIOR

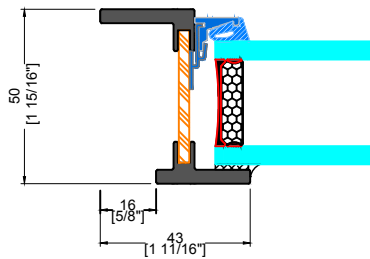

EXTERIOR

3 TYPICAL FIXED JAMB INTERIOR FLANGE

INTERIOR

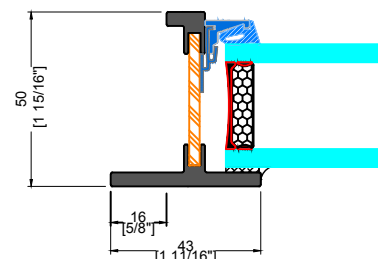

EXTERIOR

4 TYPICAL FIXED JAMB EXTERIOR FLANGE

PROJECT-IN WINDOW

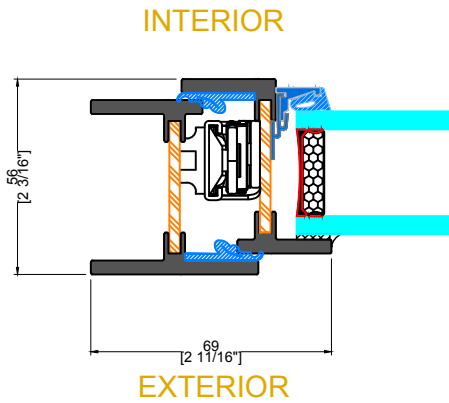

1 TYPICAL JAMB
EXTENDED FLANGE

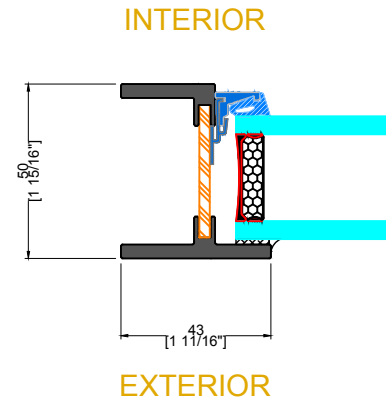

2 TYPICAL FIXED JAMB
EXTENDED FLANGE

GLAZING BEADS

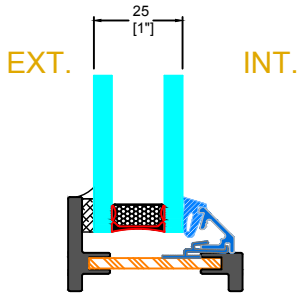

GB-04
GLAZING BEAD

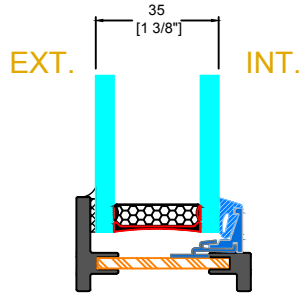

GB-05
GLAZING BEAD

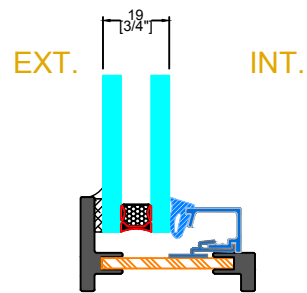

GB-06
GLAZING BEAD

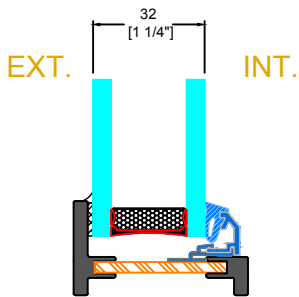

GB-12
GLAZING BEAD

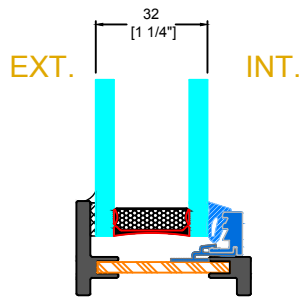

GB-13
GLAZING BEAD

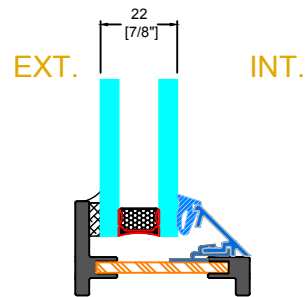

GB-15
GLAZING BEAD

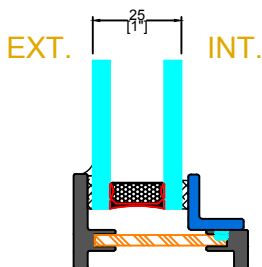

GB-18X
GLAZING BEAD

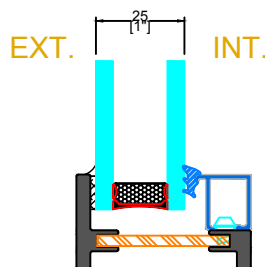

GB-31
GLAZING BEAD

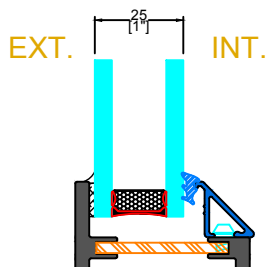

GB-35
GLAZING BEAD