

INSWING DOOR

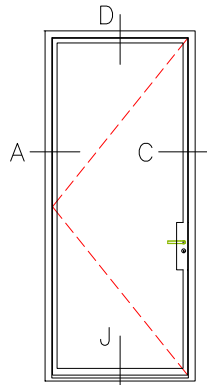

6511-ID

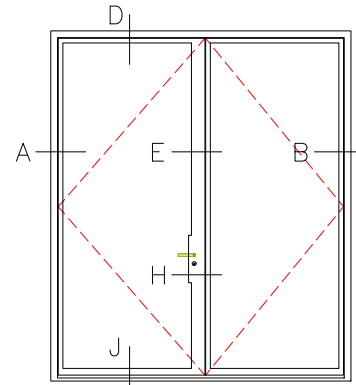

6521-FR-ID

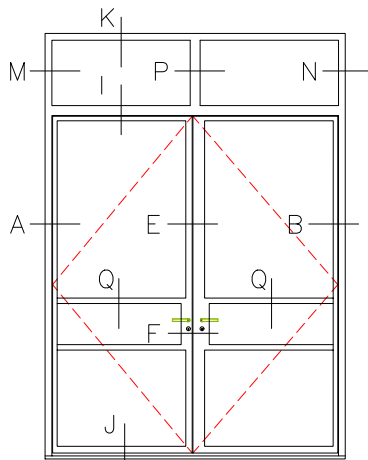

6523-FR-ID-FX

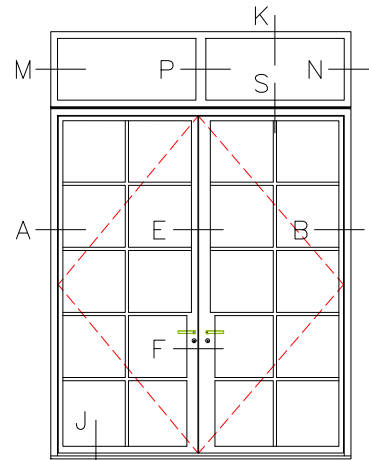

6522-FR-ID-FX

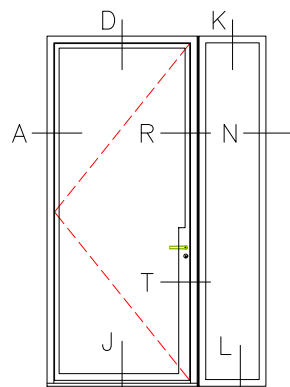

6521-ID-FX

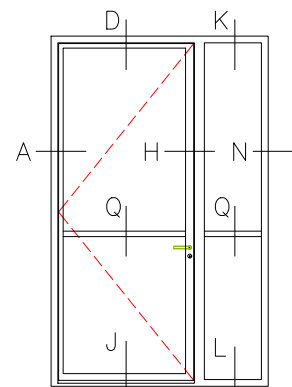

6522-ID-FX

IN SWING DOOR

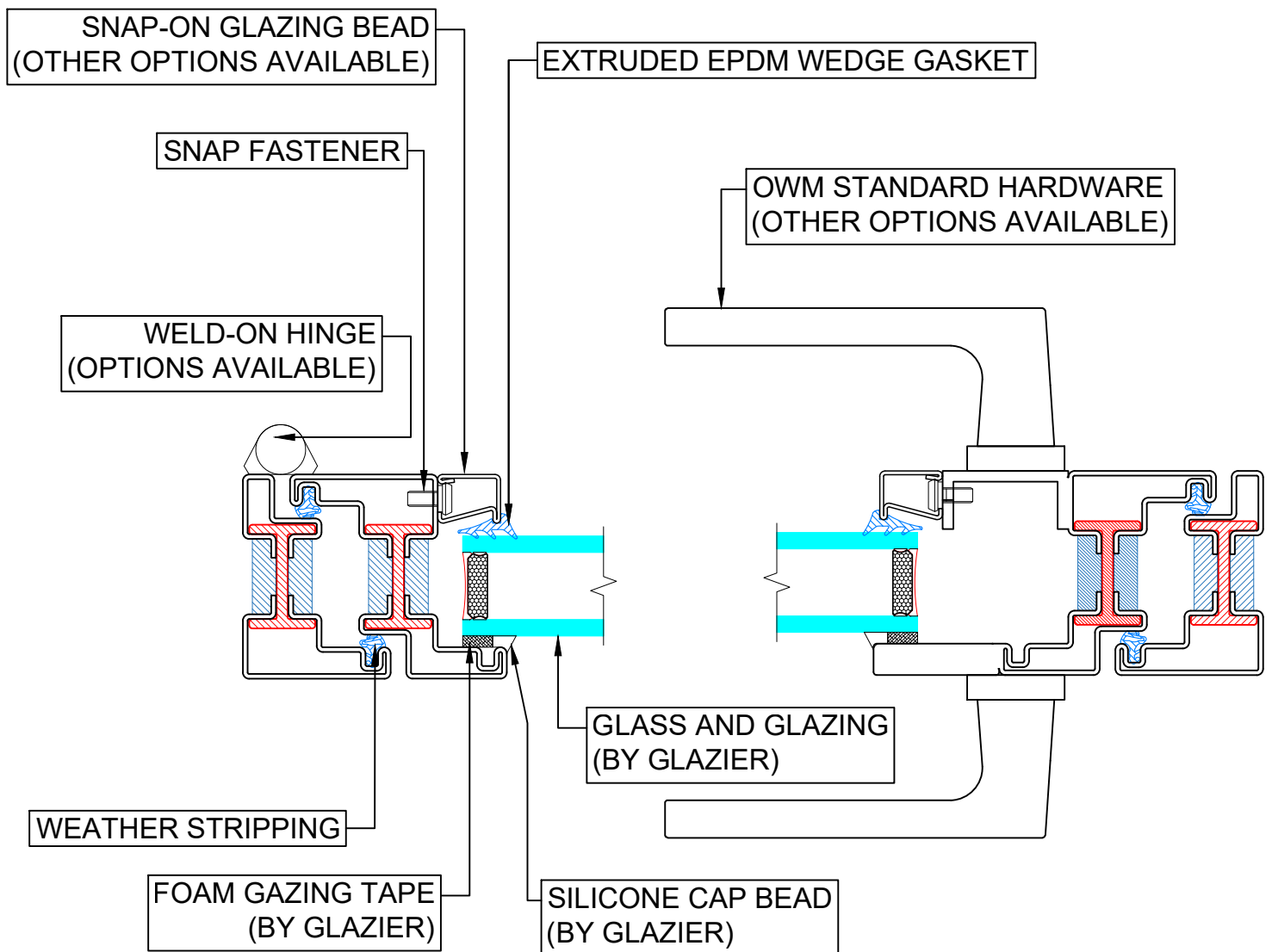

6521-ID-FX

6522-ID-FX

INSWING DOOR

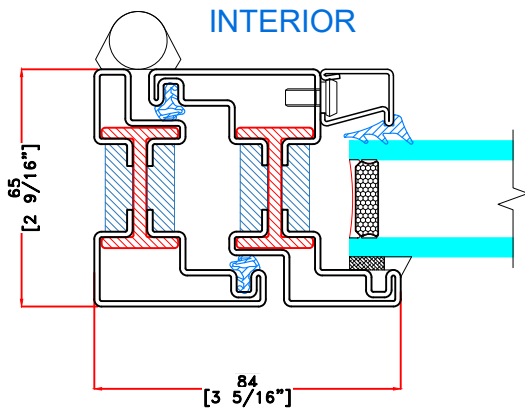

A&B TYPICAL HINGED JAMB

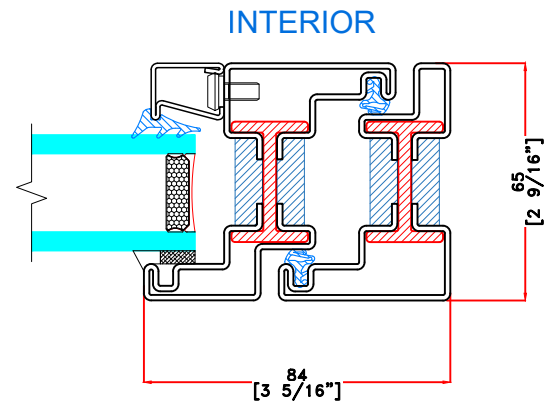

C TYPICAL LOCKING JAMB

EXTERIOR INTERIOR

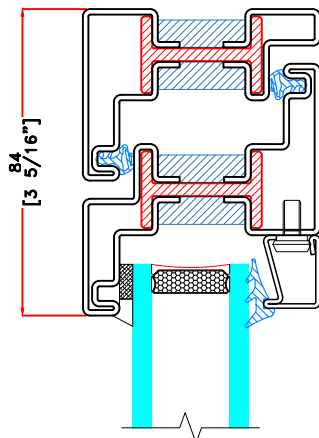

D TYPICAL HEAD

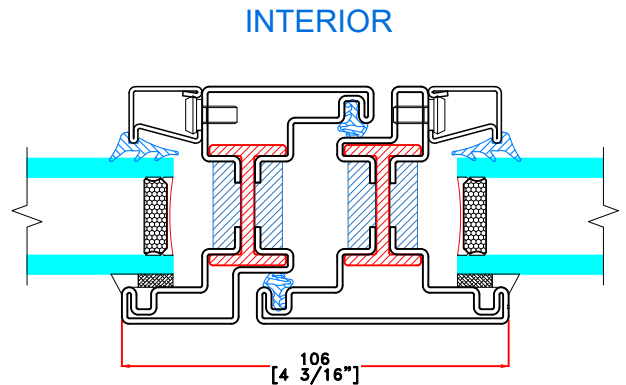

E TYPICAL FRENCH MEETING RAIL

INSWING DOOR

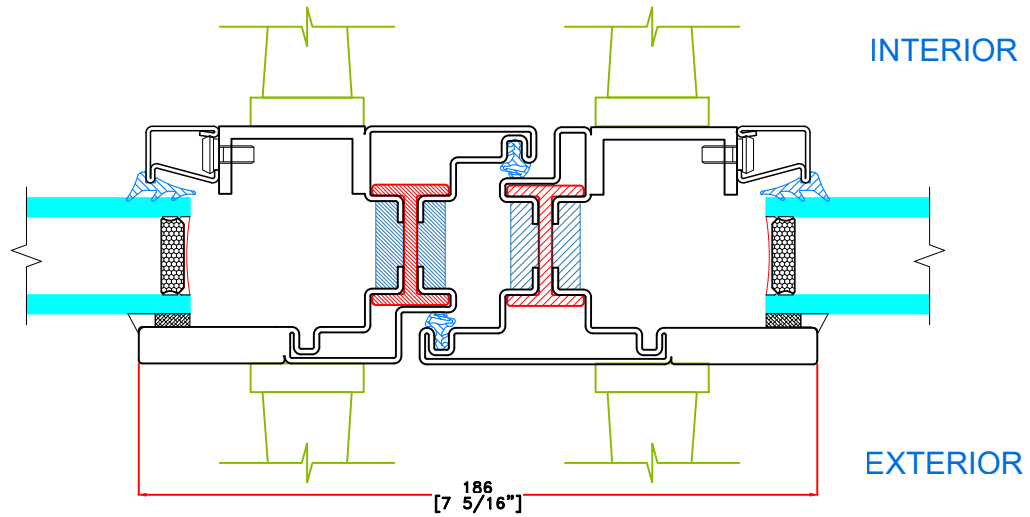

F TYPICAL FRENCH LOCKBOX

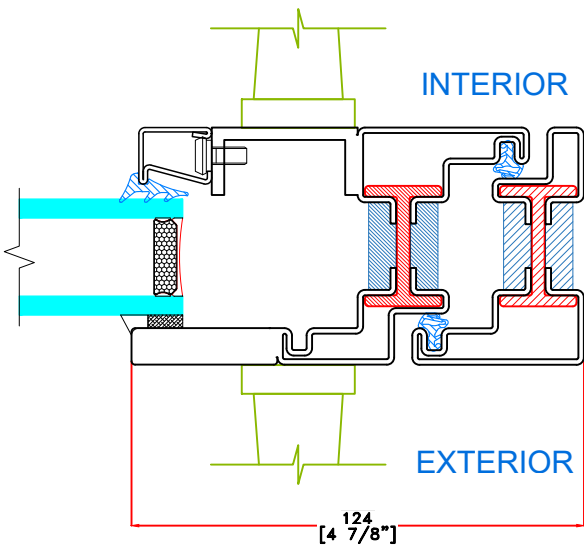

G TYPICAL SINGLE LOCKBOX

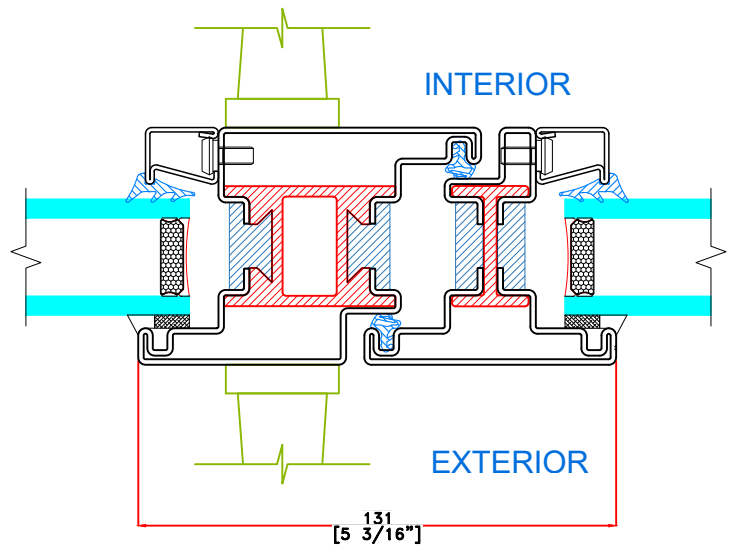

H TYPICAL FRENCH MEETING RAIL

6521-ID-FX

6522-ID-FX

INSWING DOOR

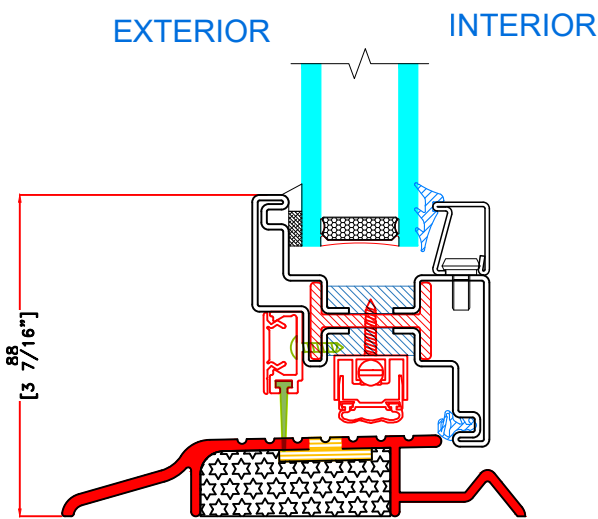

J TYPICAL KICKPALTE

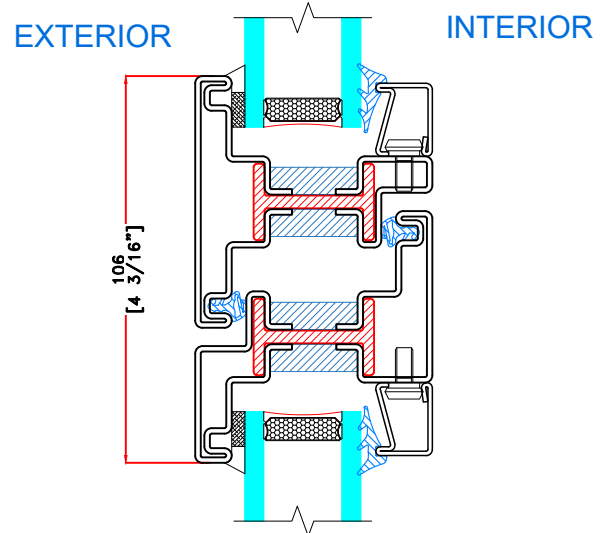

I TYPICAL FIXED/ OPERABLE MEETING RAIL

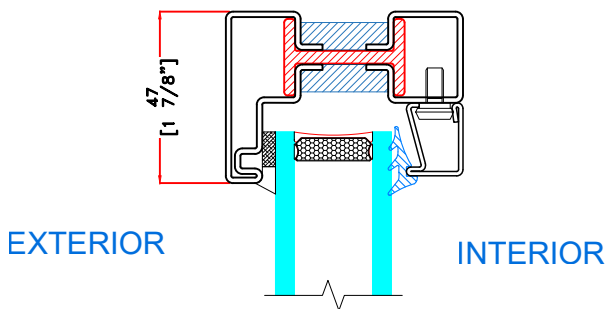

K&L TYPICAL FIXED HEAD & SILL

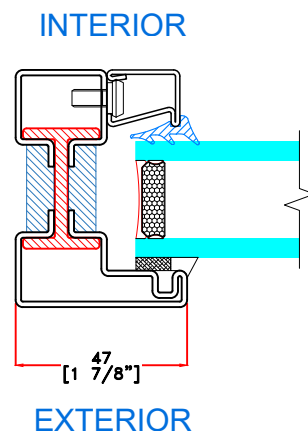

M&N TYPICAL FIXED JAMB

6521-ID-FX

6522-ID-FX

INSWING DOOR

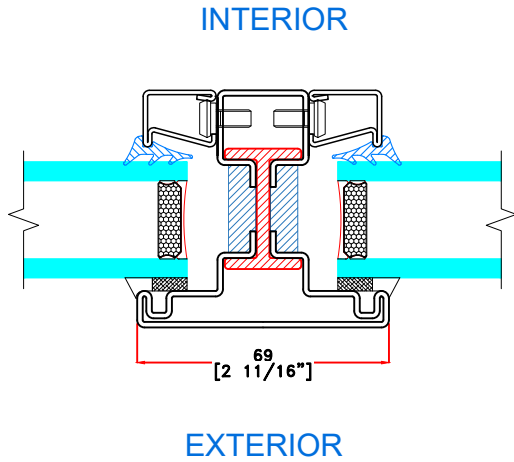

P TYPICAL VERTICAL MUNTIN

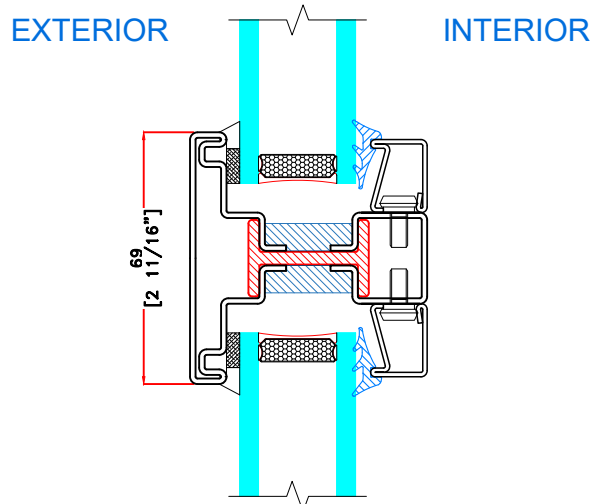

Q TYPICAL HORIZONTAL MUNTIN

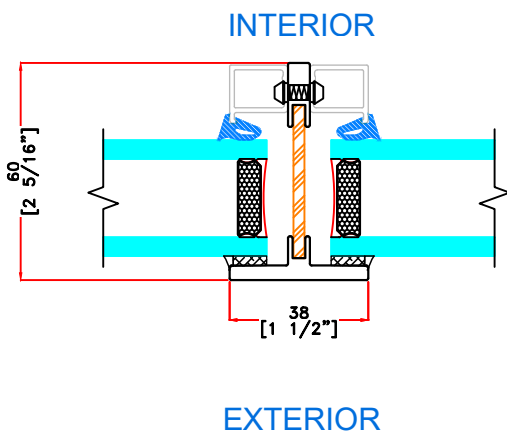

P OPTIONAL VERTICAL MUNTIN

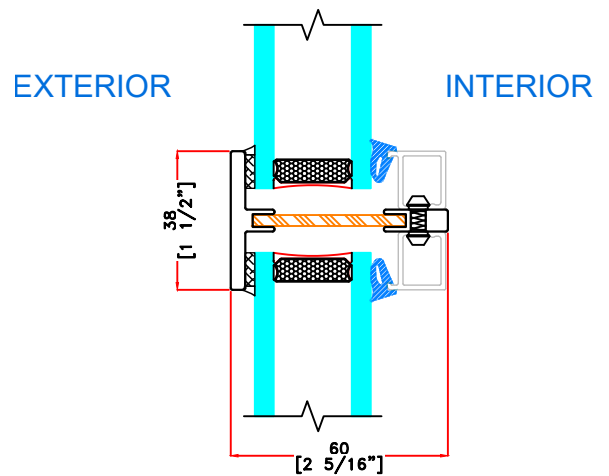

Q OPTIONAL HORIZONTAL MUNTIN

INSWING DOOR

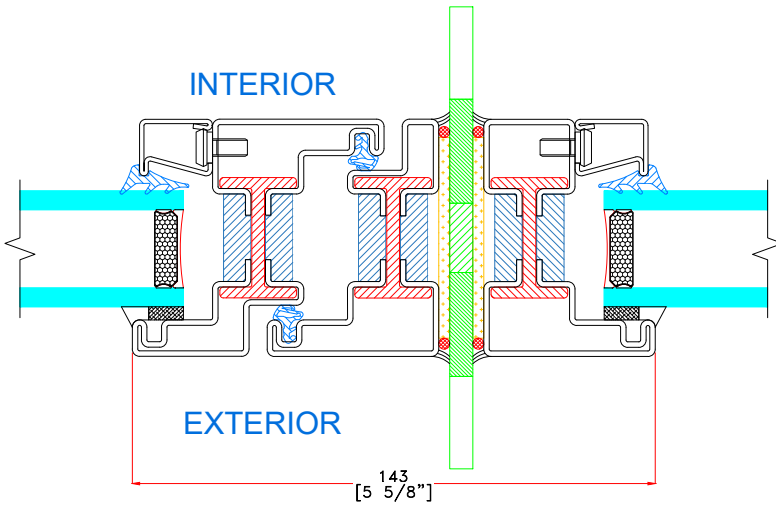

R TYPICAL JOINING MULLION

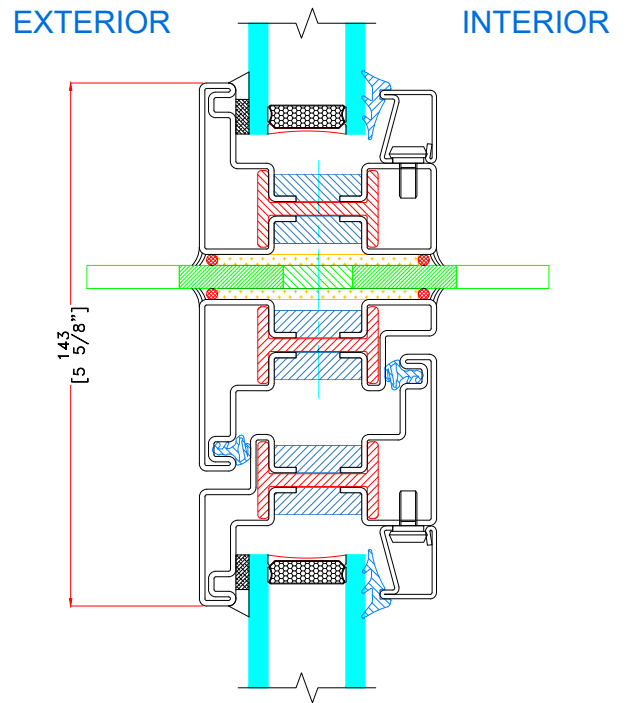

S TYPICAL STACKING MULLION

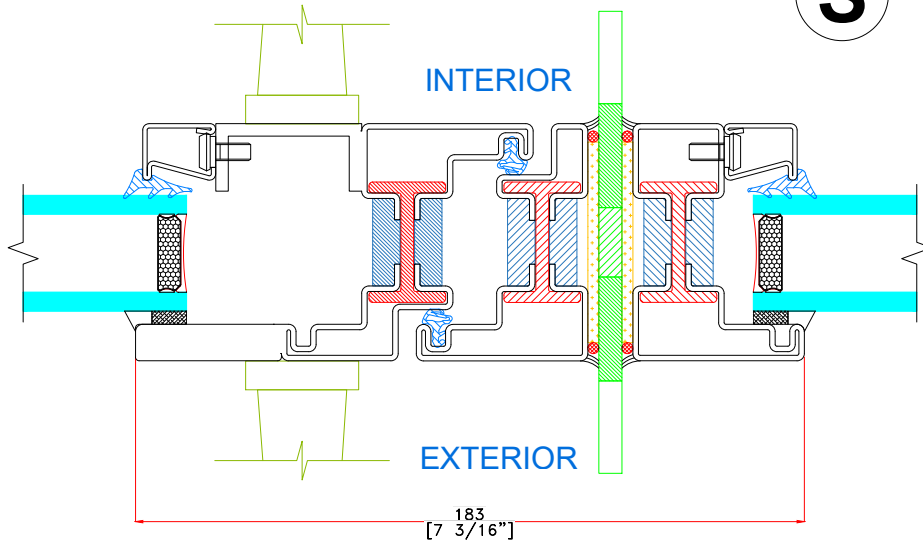

T TYPICAL SINGLE LOCKBOX

STYLE AND DESIGN OF FLAT BAR MULLION MAY VARY DEPENDENT UPON ENGINEERING REQUIREMENTS

IN SWING DOOR

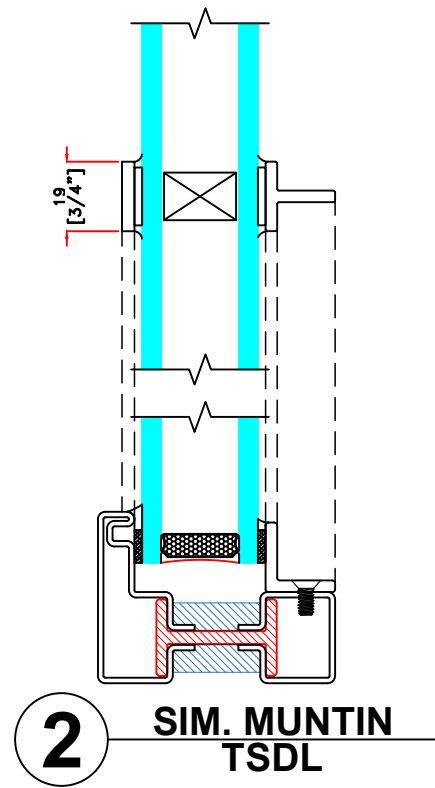
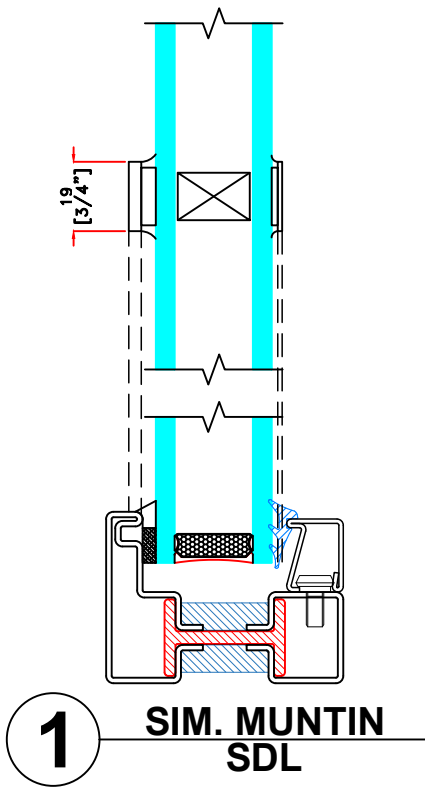

IN SWING DOOR INTERIOR GLAZING

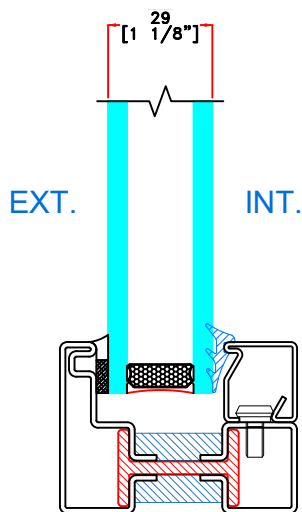

GB-1007
GLAZING BEAD

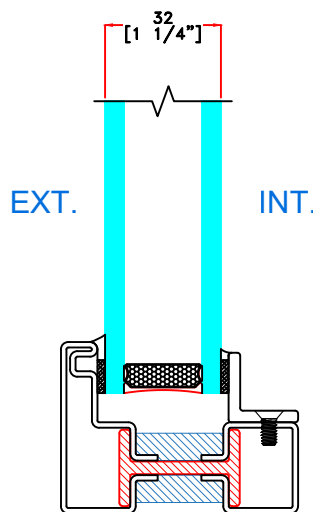

GB18-.75
GLAZING BEAD

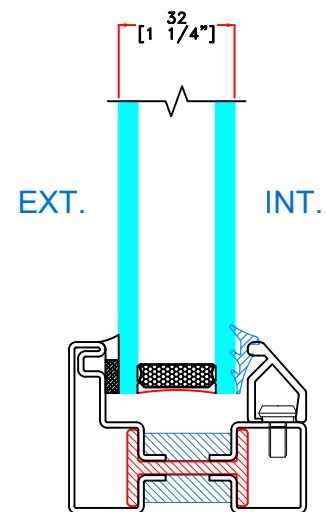

GB-22
GLAZING BEAD