

OUTSWING DOOR

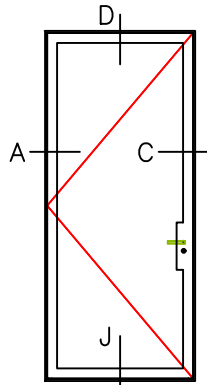

6511-OD

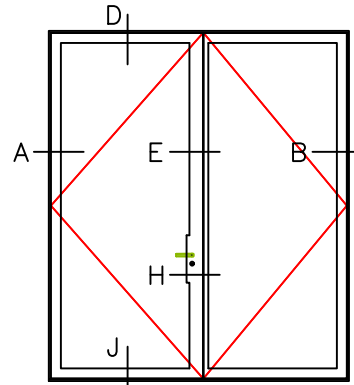

6521-FR-OD

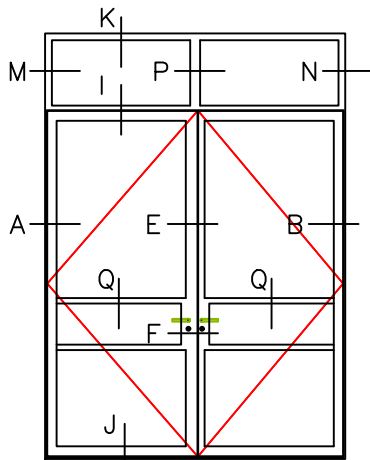

6522-FR-OD-FX

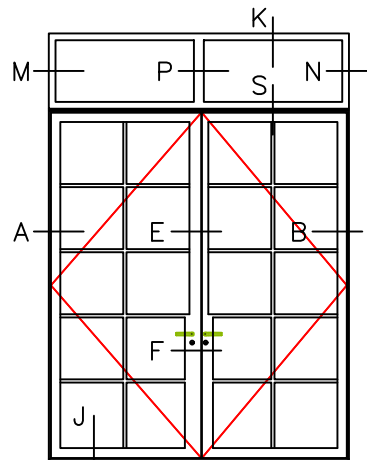

6522-FR-OD-FX

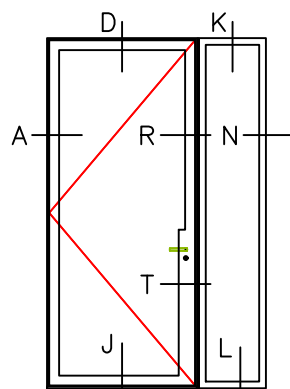

6521-OD-FX

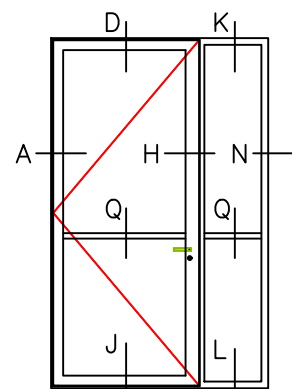

6522-OD-FX

OUTSWING DOOR

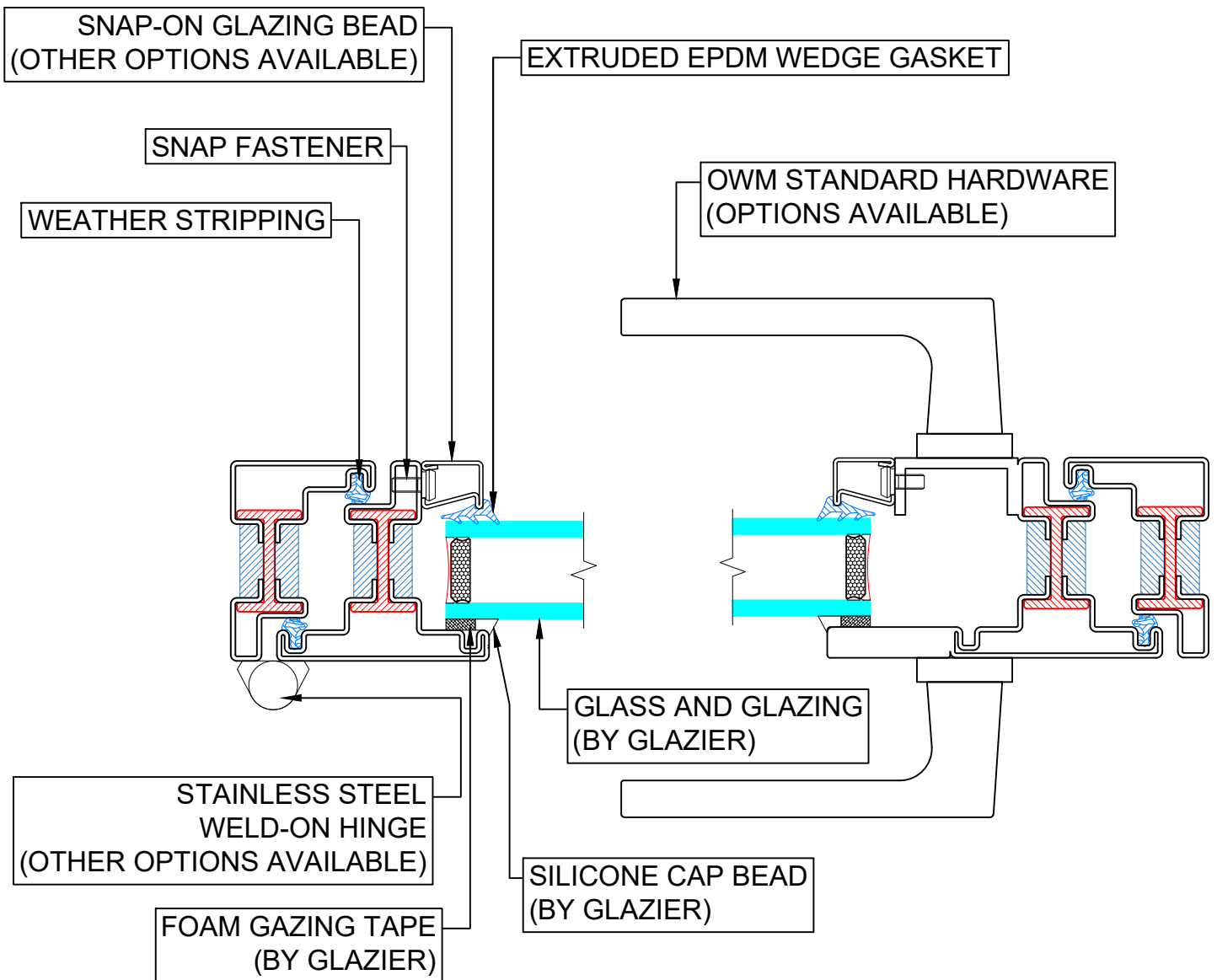

OUTSWING DOOR

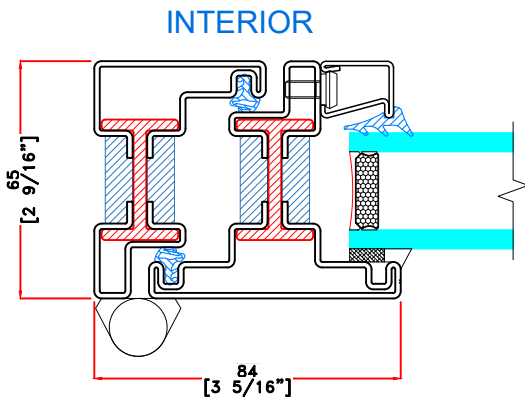

A&B TYPICAL HINGED JAMB

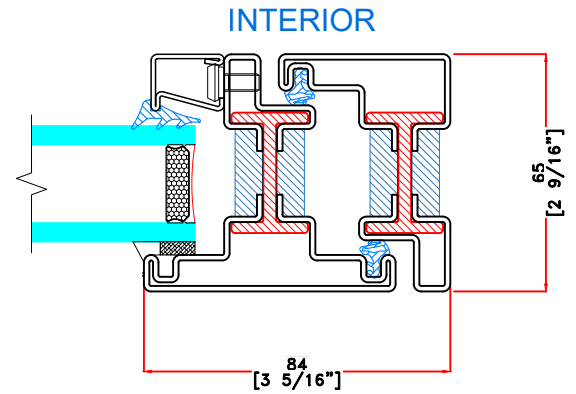

C TYPICAL LOCKING JAMB

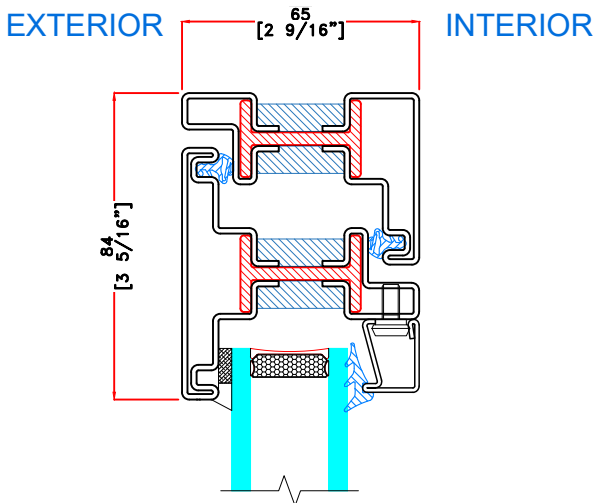

D TYPICAL HEAD

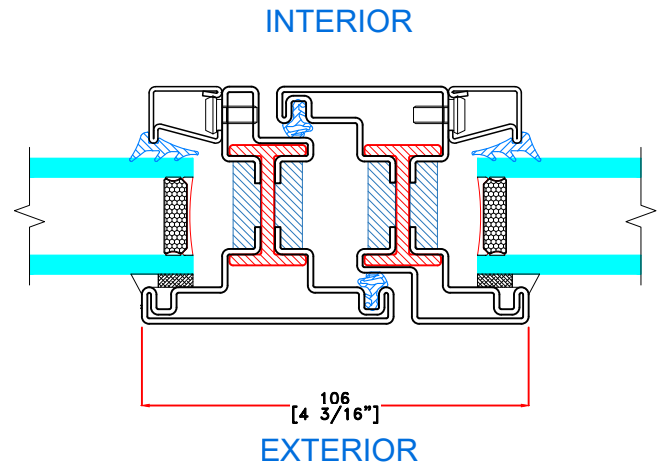

E TYPICAL FRENCH MEETING RAIL

OUTSWING DOOR

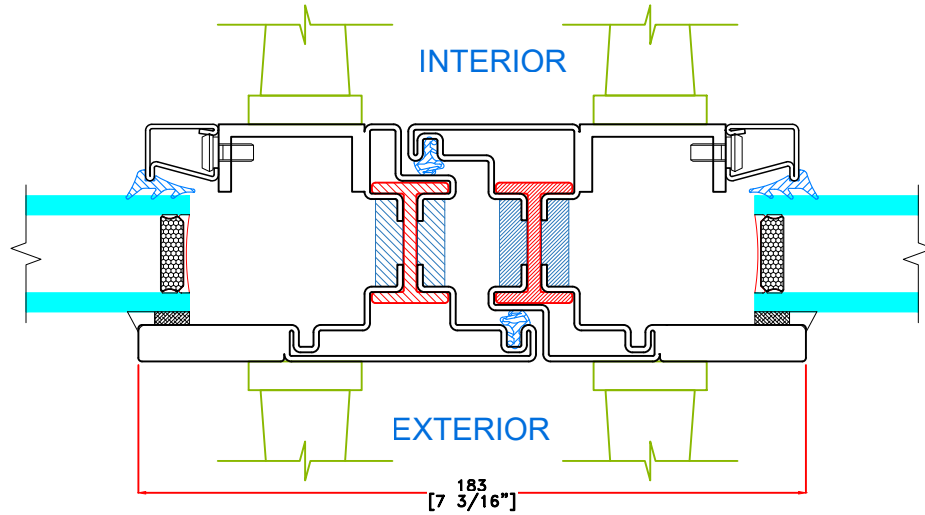

F TYPICAL FRENCH LOCKBOX

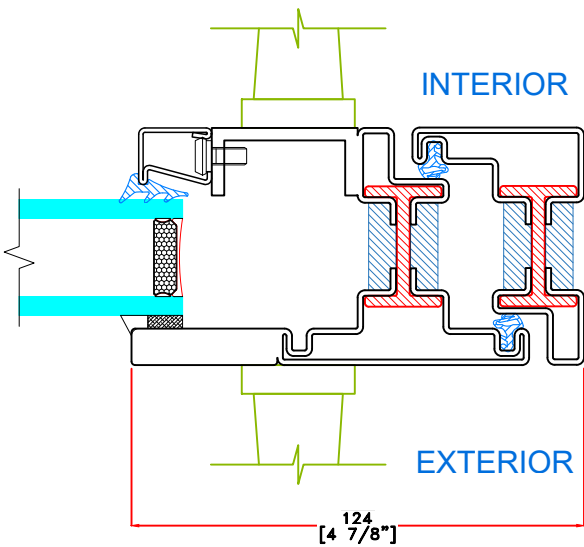

G TYPICAL SINGLE LOCKBOX

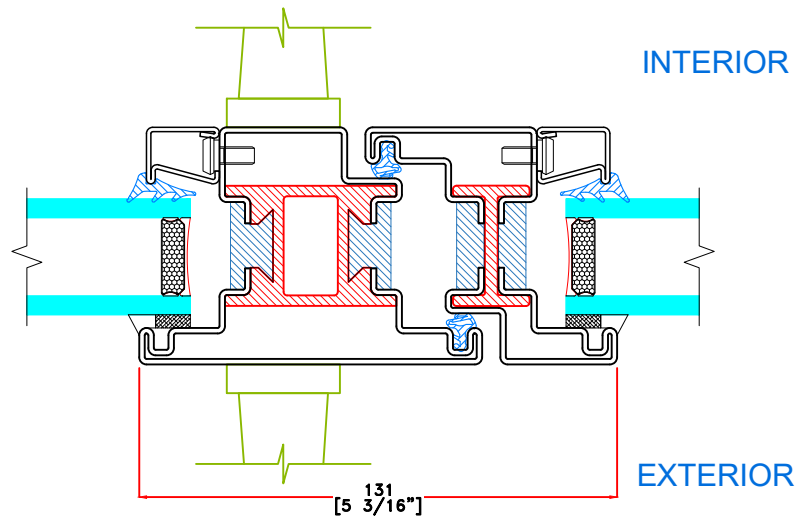

H OPTIONAL FRENCH MEETING RAIL

OUTSWING DOOR

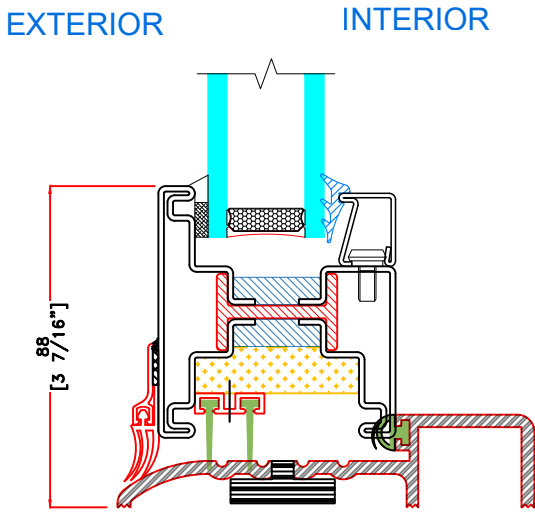

J TYPICAL KICKPALTE

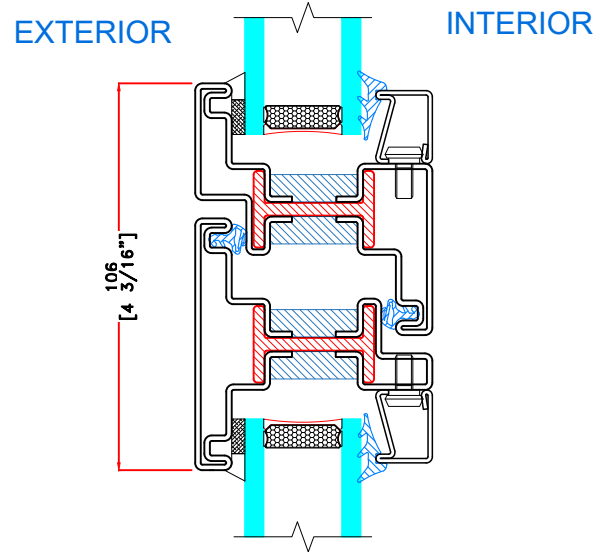

I TYPICAL FIXED/ OPERABLE MEETING RAIL

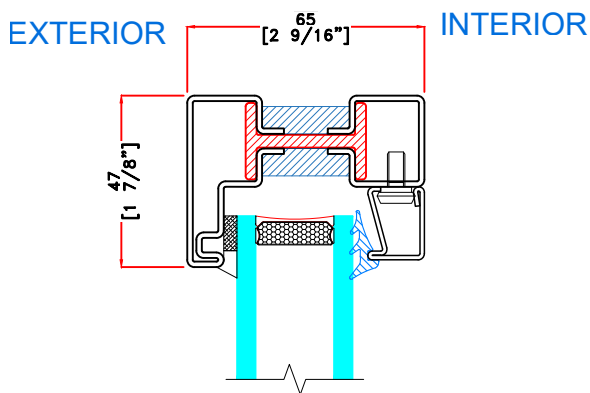

K&L TYPICAL FIXED HEAD & SILL

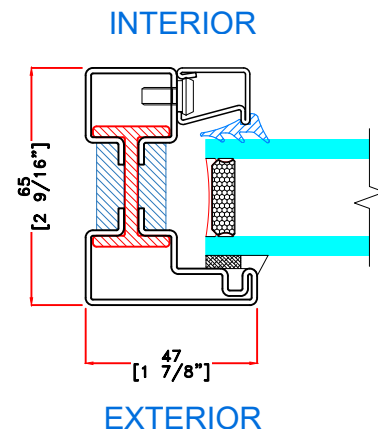

M&N TYPICAL FIXED JAMB

OUTSWING DOOR

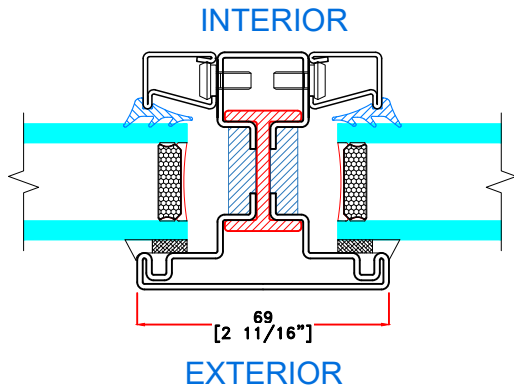

P TYPICAL VERTICAL MUNTIN

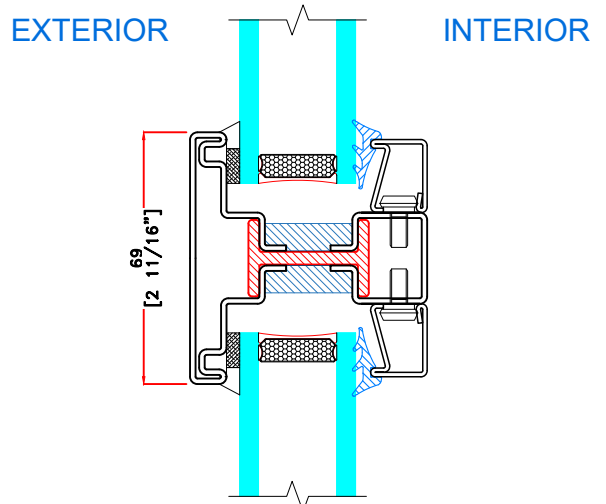

Q TYPICAL HORIZONTAL MUNTIN

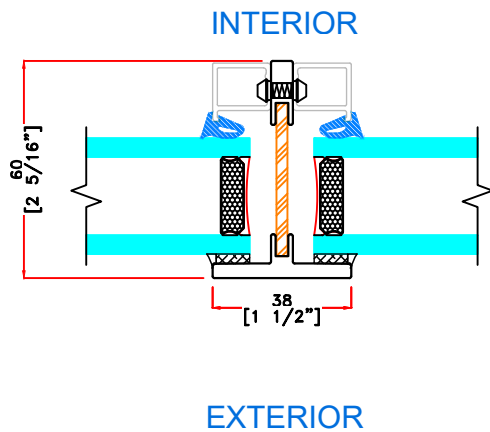

P OPTIONAL VERTICAL MUNTIN

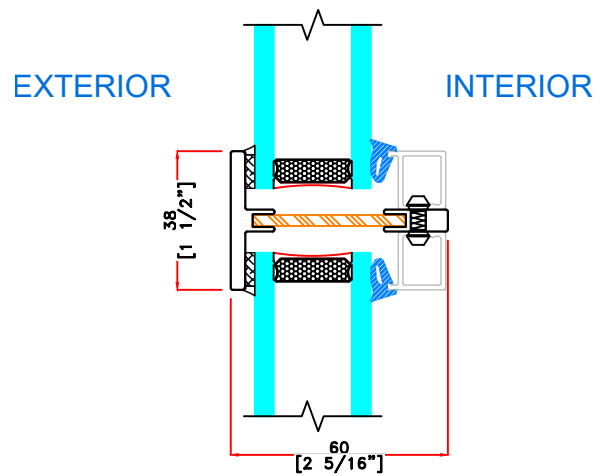

Q OPTIONAL HORIZONTAL MUNTIN

OUTSWING DOOR

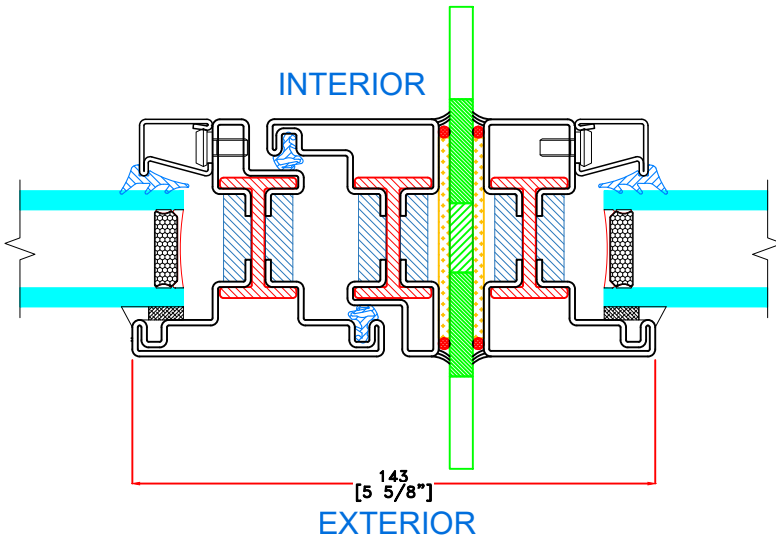

R TYPICAL JOINING MULLION

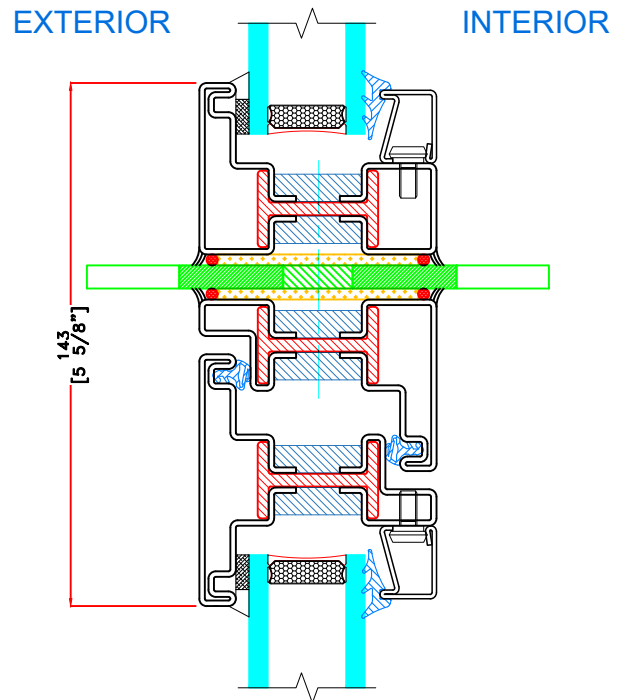

S TYPICAL STACKING MULLION

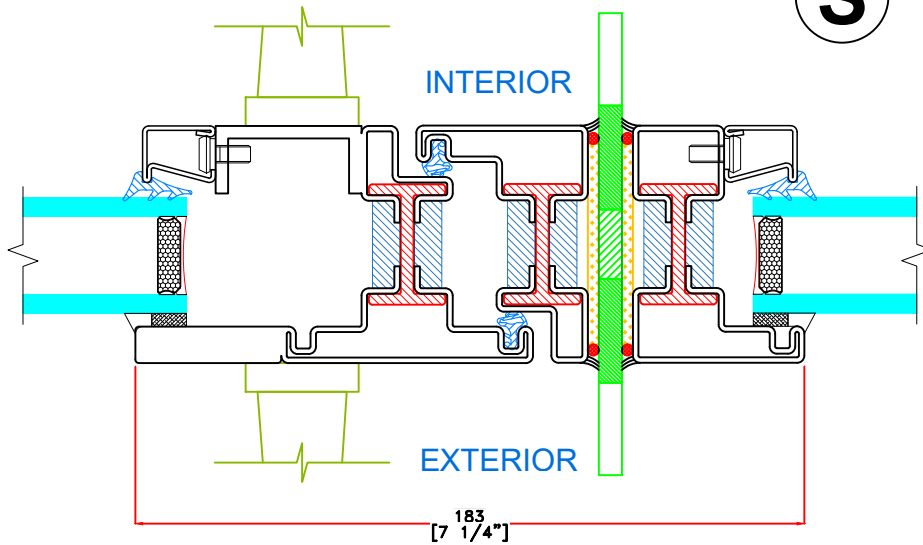

T TYPICAL SINGLE LOCKBOX

STYLE AND DESIGN OF FLAT BAR MULLION MAY VARY DEPENDENT UPON ENGINEERING REQUIREMENTS

OUTSWING DOOR

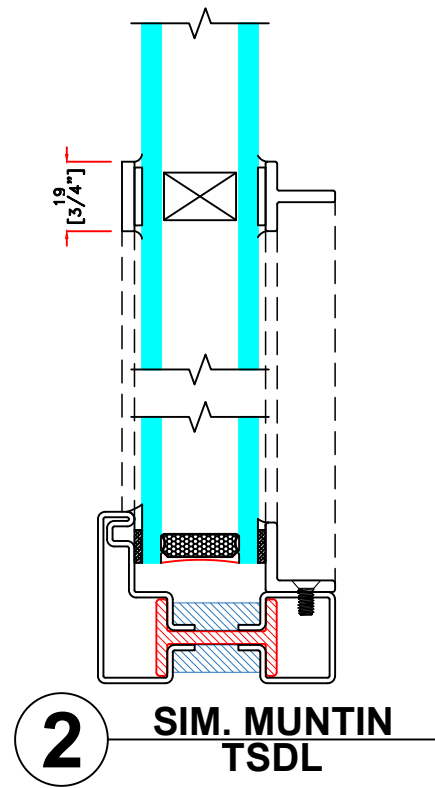
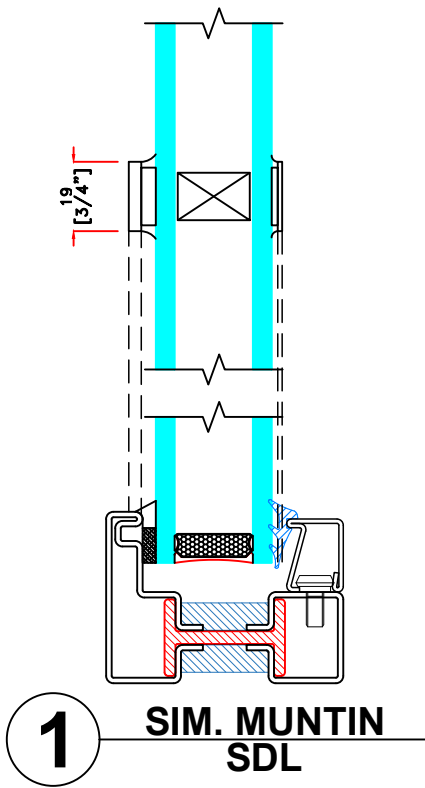

OUTSWING DOOR INTERIOR GLAZING

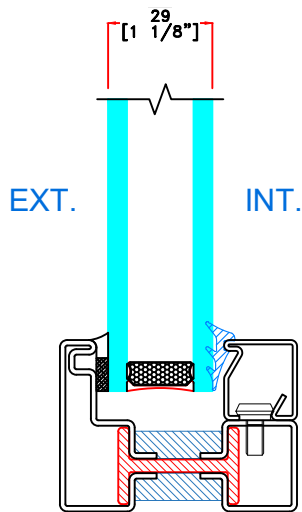

GB-1007
GLAZING BEAD

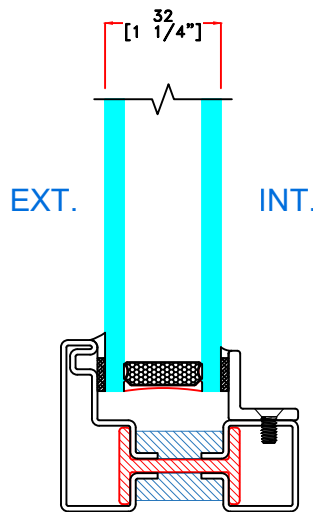

GB18-.75
GLAZING BEAD

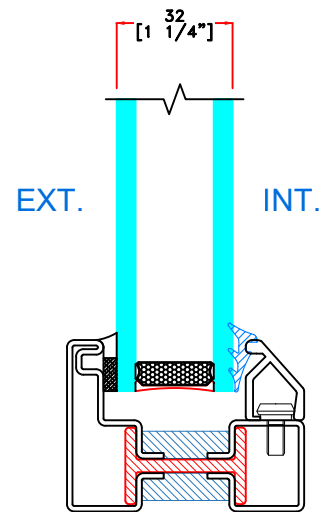

GB-22
GLAZING BEAD