

Typical Exterior Elevations

PROJECT IN / FIXED
Scale: Not To Scale

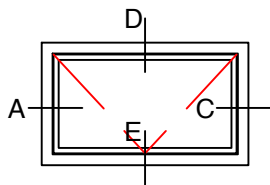

680-11-PI

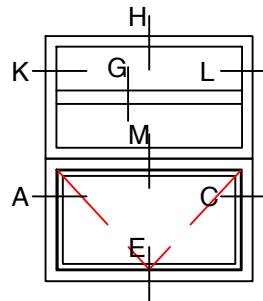

680-14-PI-FX

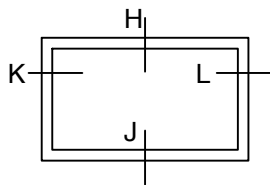

680-11-FX

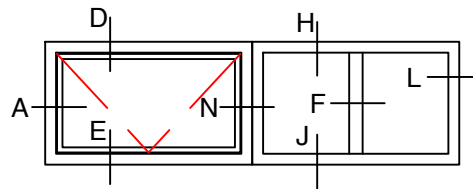

680-41-PI-FX



Typical Details

PROJECT IN / FIXED
Scale: Half Scale

PAGE 2 OF 5

KEY (TYPICAL)

1. SNAP IN ALUMINUM GLAZING BEAD
2. WEDGE GASKET
3. 1" GLASS AND GLAZING (BY OTHERS)
4. WEATHER STRIPPING
5. METRO STAINLESS STEEL 4 BAR HINGE
6. METRO HANDLE (OTHER OPTIONS AVIABLE)

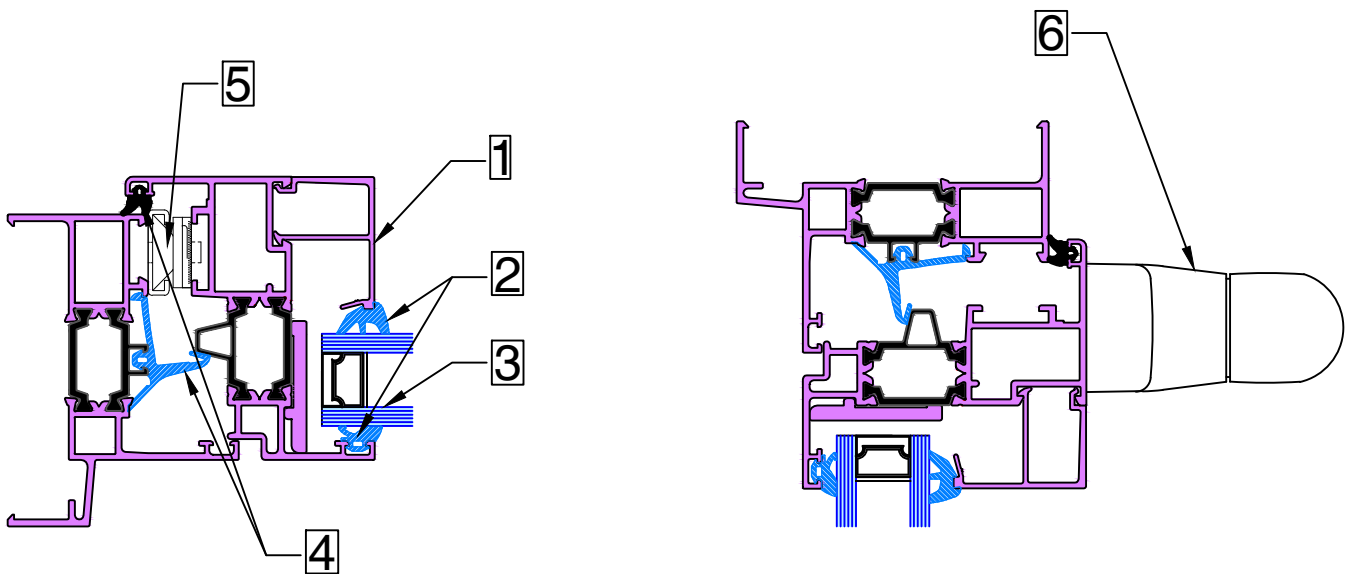

Typical Details

PROJECT IN / FIXED
Scale: Half Scale

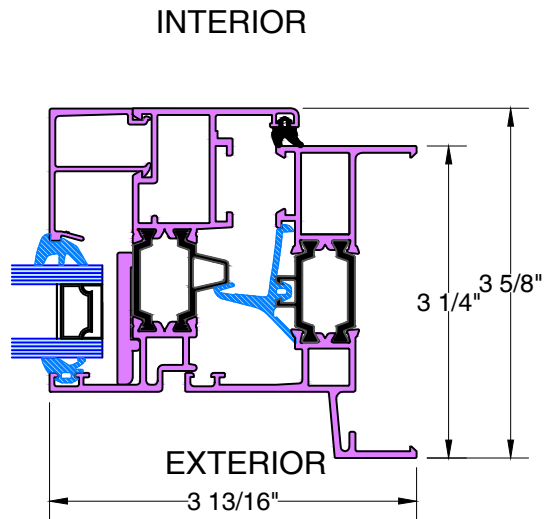
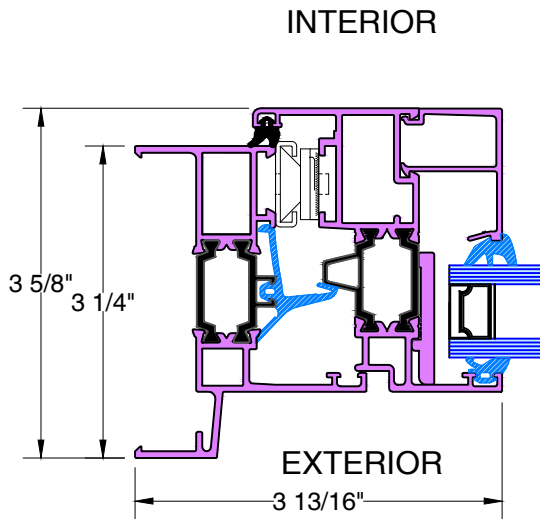

A&B TYPICAL HINGED JAMB

C TYPICAL LOCKING JAMB

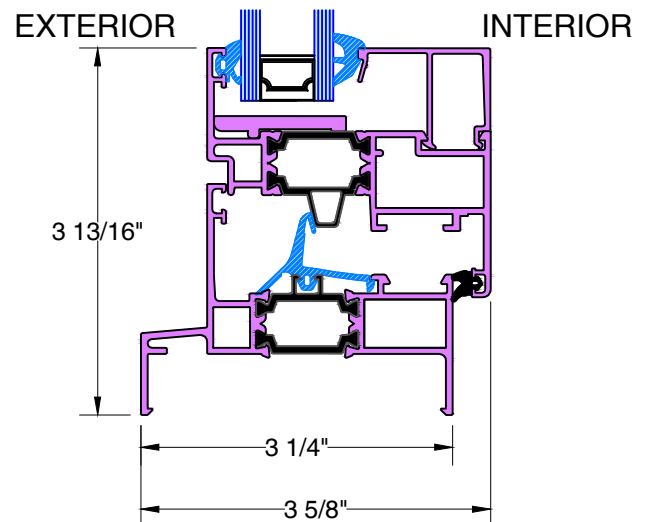
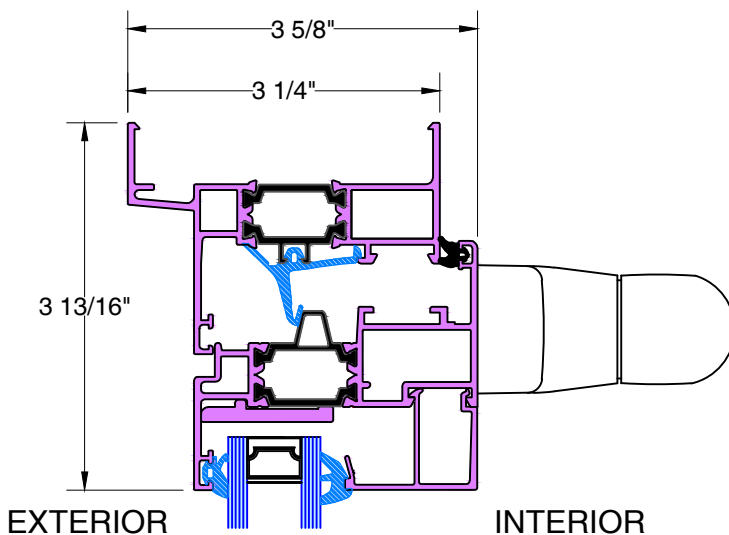

D TYPICAL HEAD

E TYPICAL SILL



Typical Details

PROJECT IN / FIXED
Scale: Half Scale

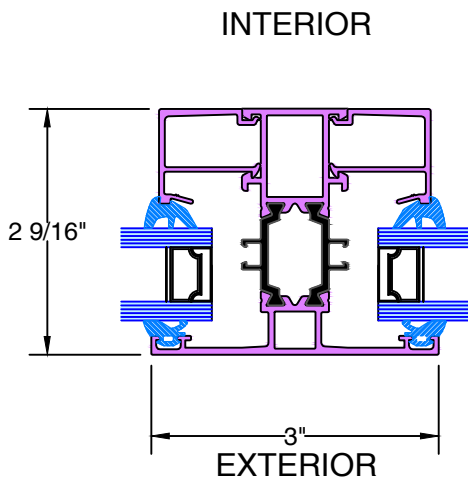

F TYPICAL VERTICAL MUNTIN

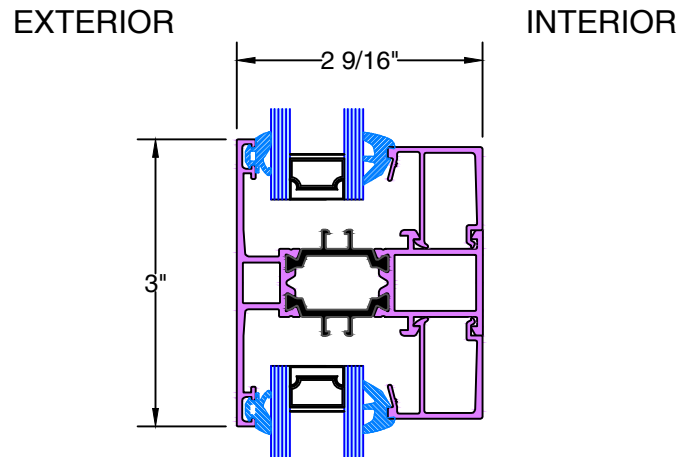

G TYPICAL HORIZONTAL MUNTIN

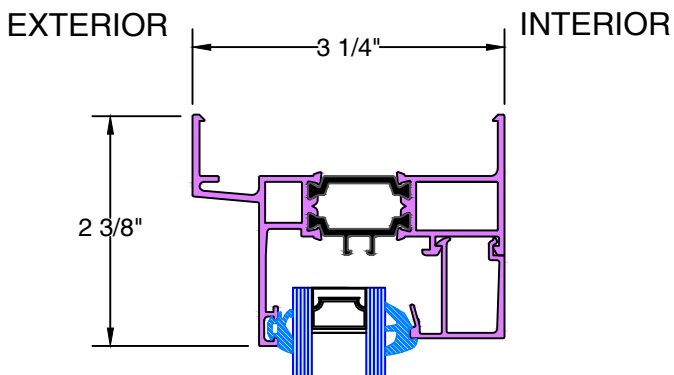

H&J TYPICAL FIXED HEAD & SILL

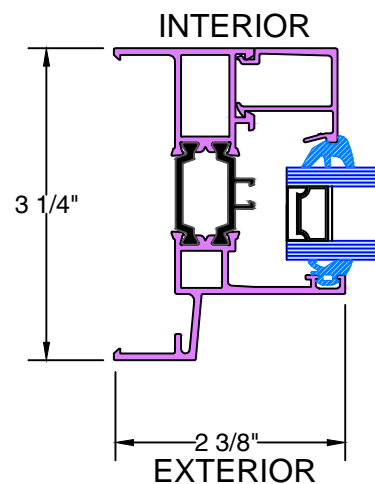

K&L TYPICAL FIXED JAMB



Typical Details

PROJECT IN / FIXED

Scale: Half Scale

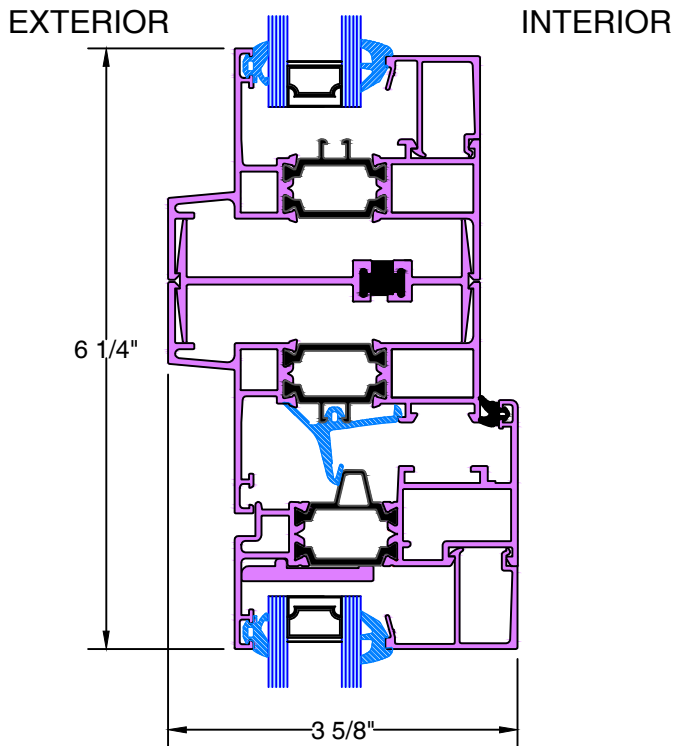

M TYPICAL STACKING MULLION

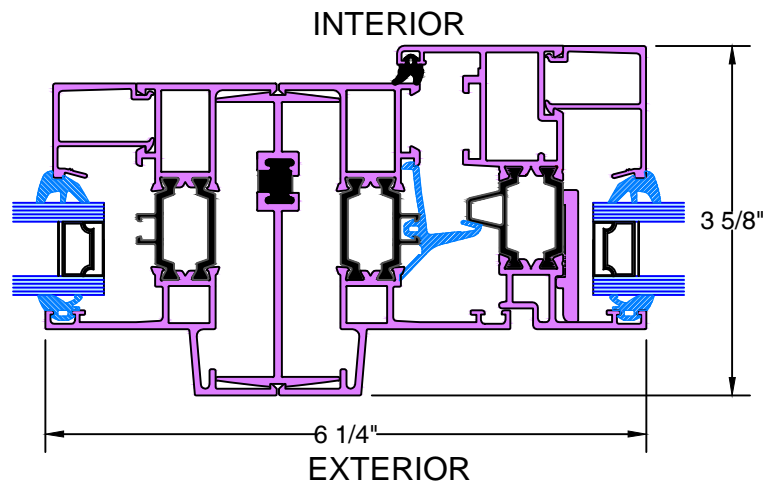

N TYPICAL JOINING MULLION

