

DETENTION

Typical Exterior Elevations

DET 9000 SERIES

Scale: Not To Scale

PAGE 1 OF 8

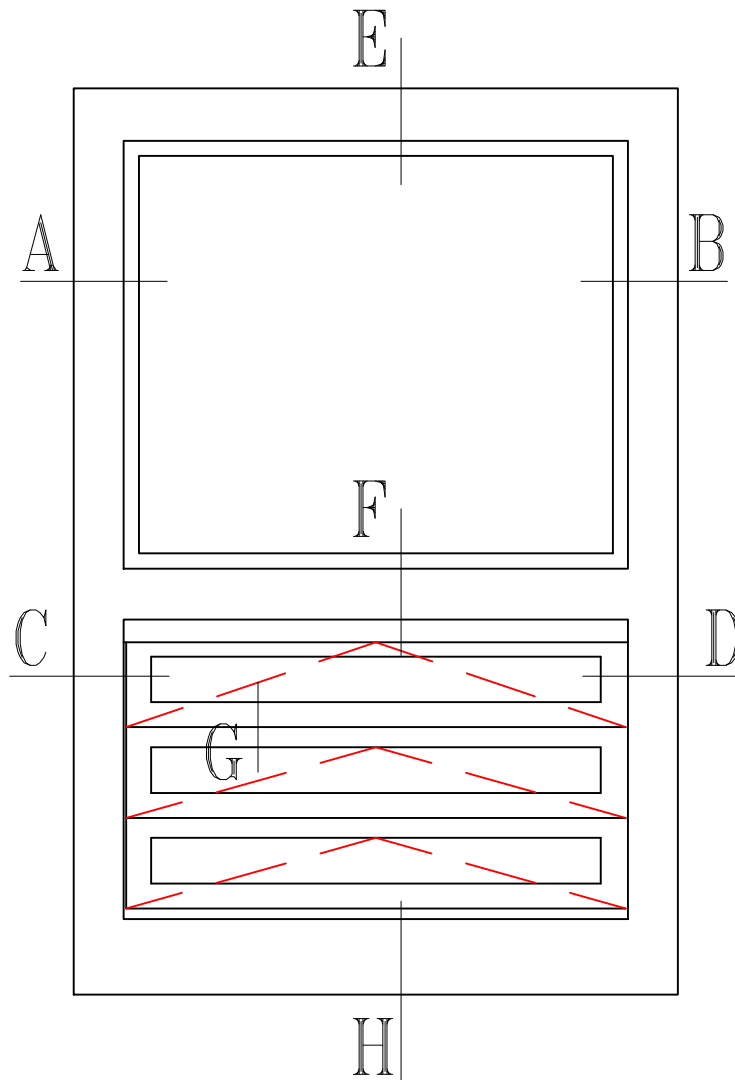

28 Canal Street, Ellenville, NY 12428
Phone (845) 647-1900

KEY (TYPICAL)

1. Steel glazing bead (by OWM)
2. Silicone cap bead (by OWM)
3. Foam glazing tape (by OWM)
4. M-1 glass 1" overall thickness (by OWM)
5. Wedge gasket (by OWM)
6. Stainless steel screen mesh (by OWM)
7. 12 gauge galv. steel
8. $\frac{7}{8}$ " hardened steel
9. Thermal isolator
10. S-10 glass $1\frac{5}{16}$ " overall thickness (by OWM)

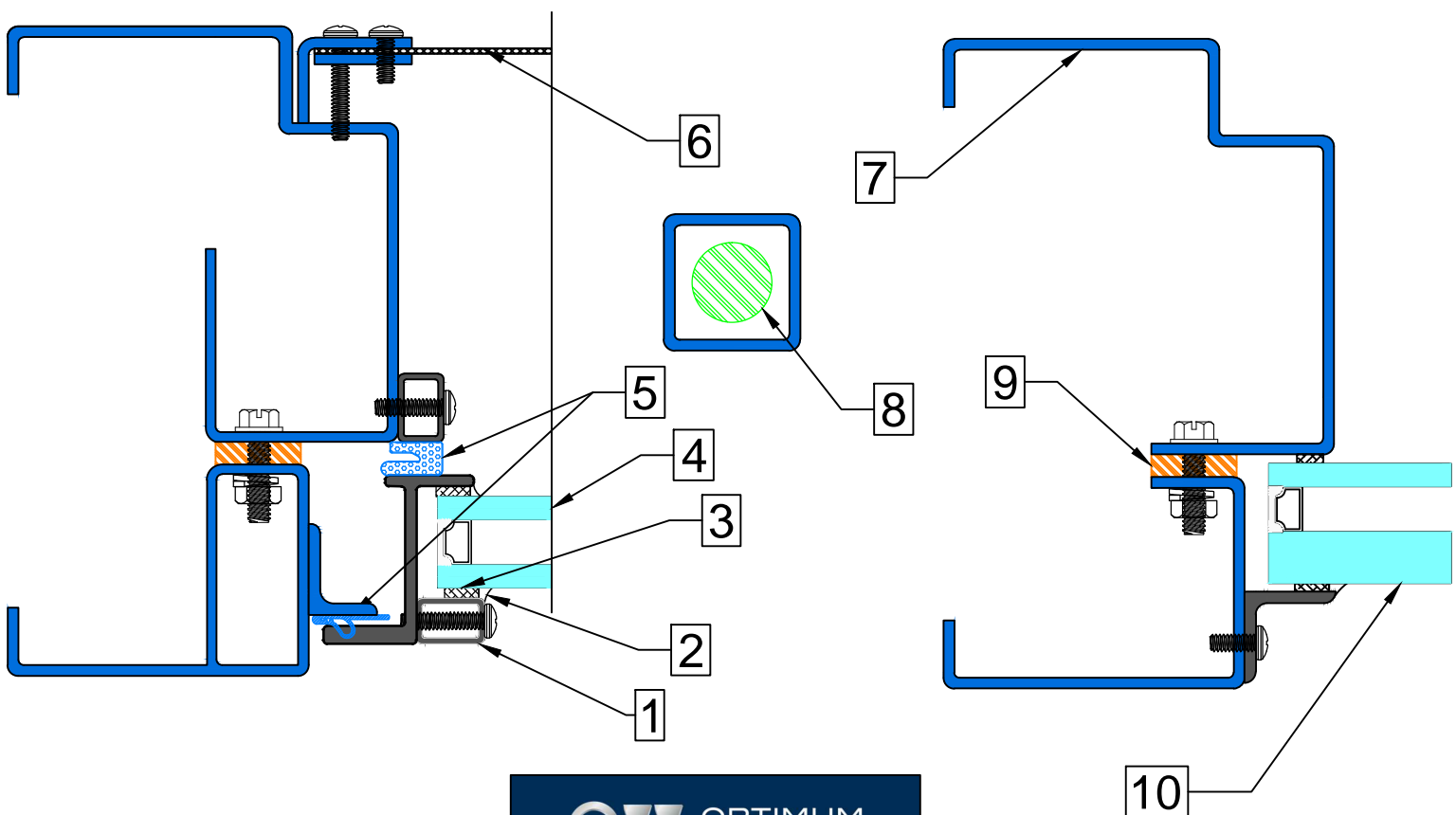

DETENTION

Typical Details

DET 9000 SERIES

Scale: Half

PAGE 3 OF 8

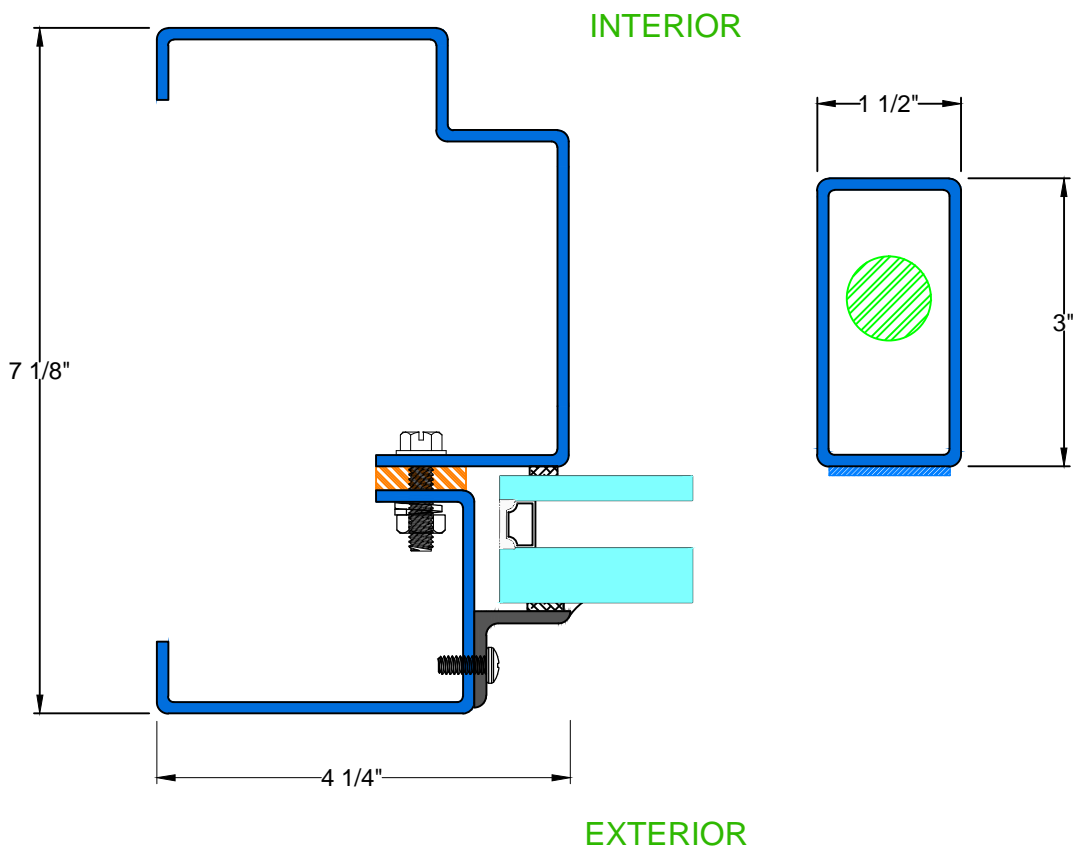

A&B ——— **TYPICAL
FIXED JAMB**



28 Canal Street, Ellenville, NY 12428
Phone (845) 647-1900

DETENTION

Typical Details

DET 9000 SERIES

Scale: Half

PAGE 4 OF 8

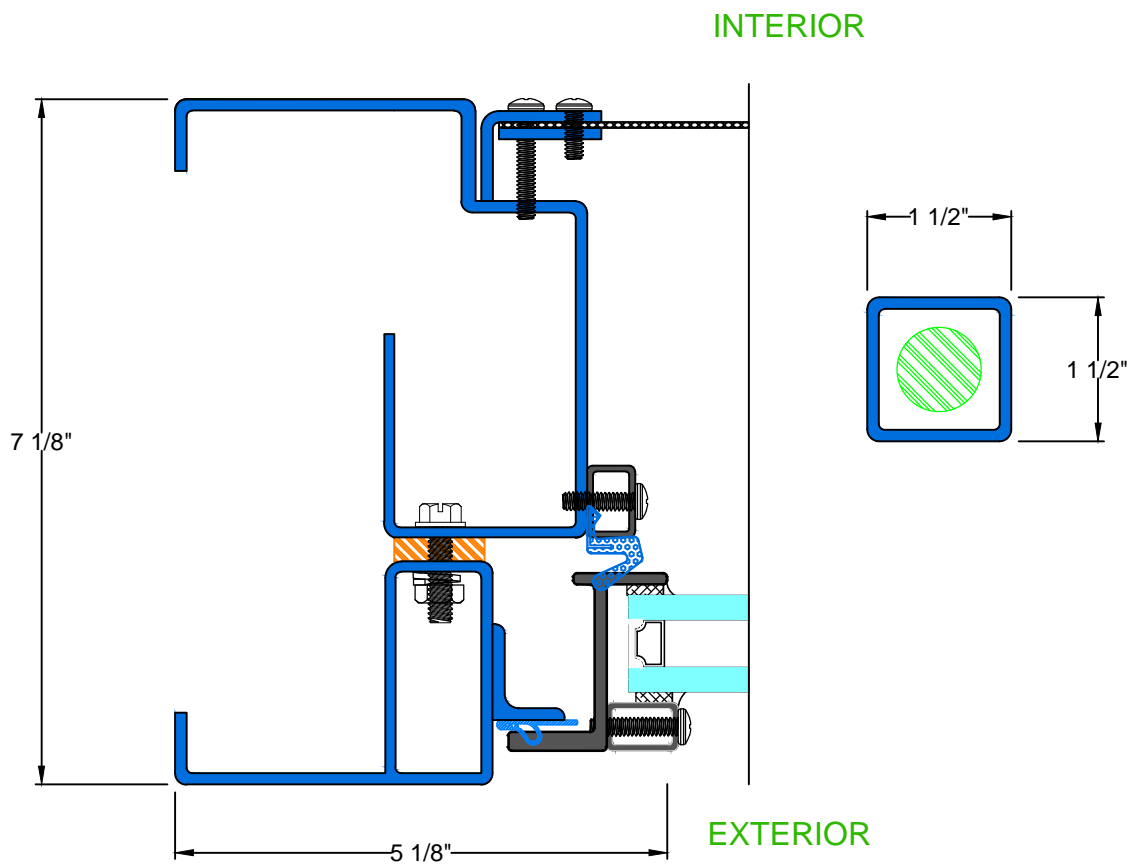

C&D TYPICAL OPERABLE JAMB



28 Canal Street, Ellenville, NY 12428
Phone (845) 647-1900

DETENTION

Typical Details

DET 9000 SERIES

Scale: Half

PAGE 5 OF 8

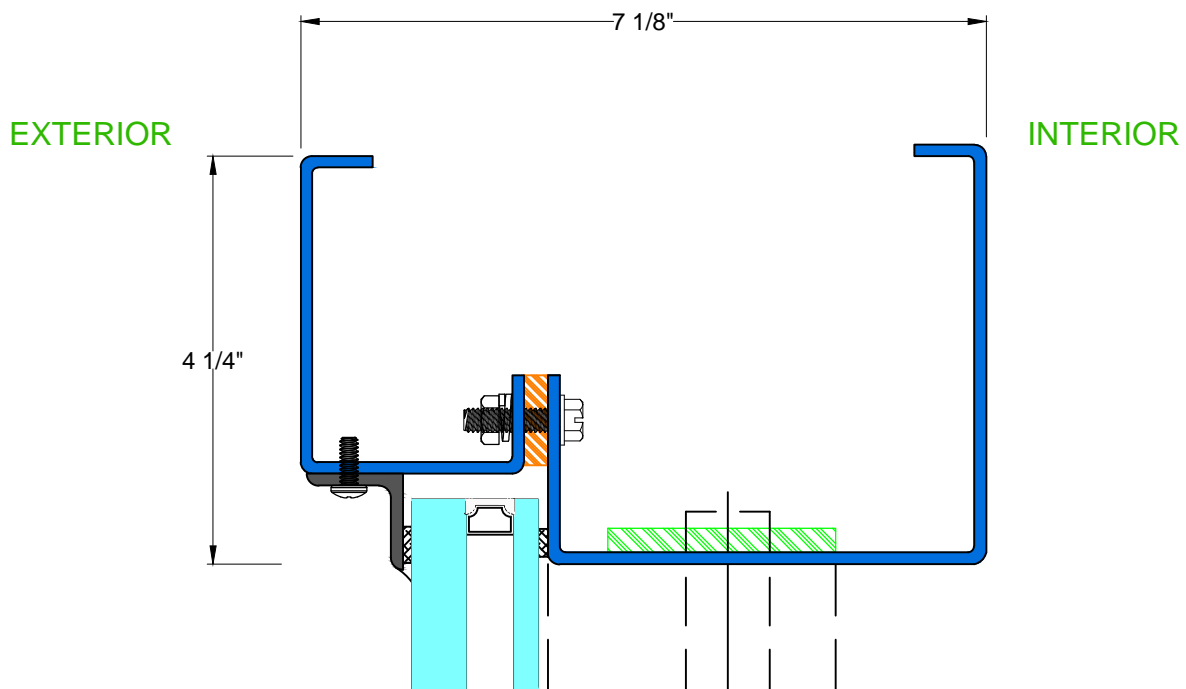

E TYPICAL HEAD



28 Canal Street, Ellenville, NY 12428
Phone (845) 647-1900

DETENTION

Typical Details

DET 9000 SERIES

Scale: Half

PAGE 6 OF 8

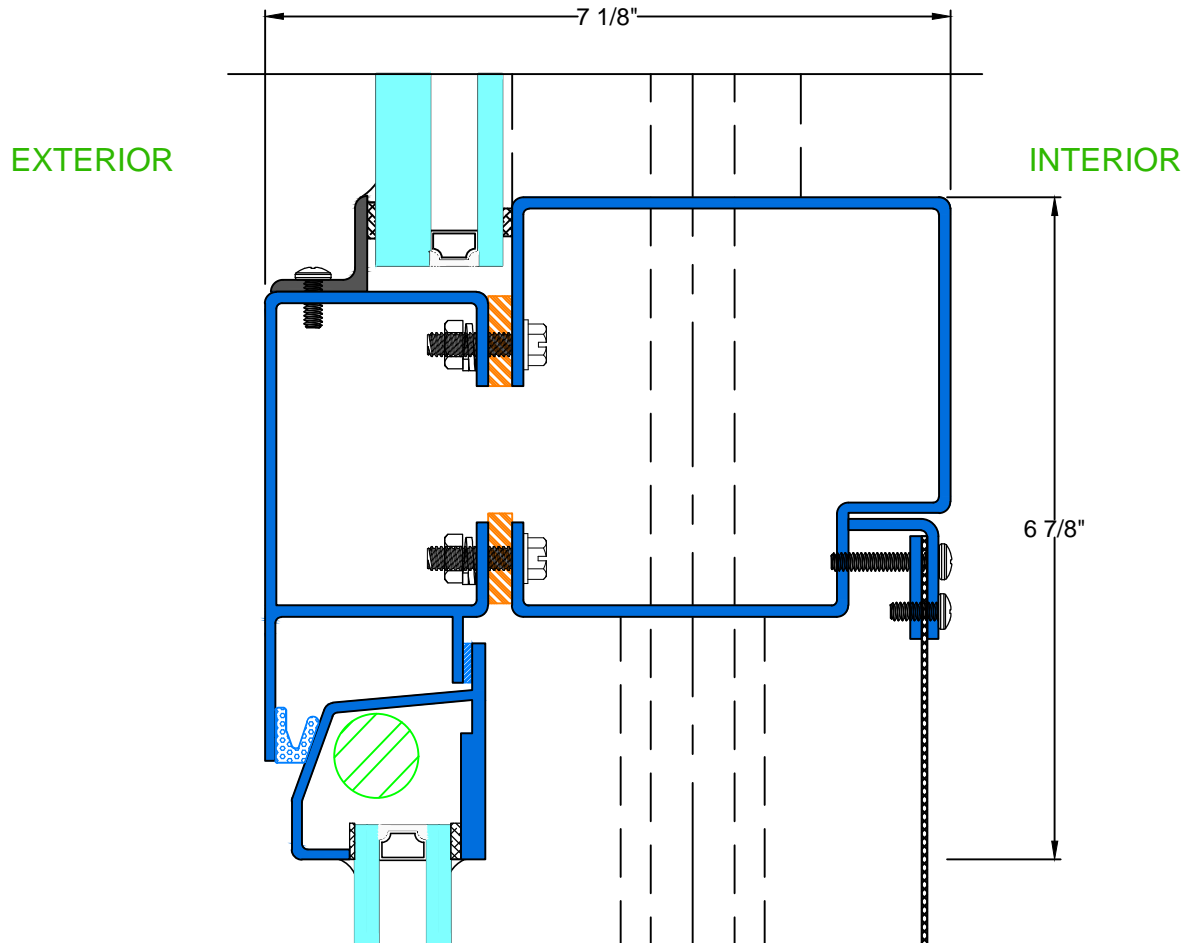

F TYPICAL MULLION



28 Canal Street, Ellenville, NY 12428
Phone (845) 647-1900

DETENTION

Typical Details

DET 9000 SERIES

Scale: Half

PAGE 7 OF 8

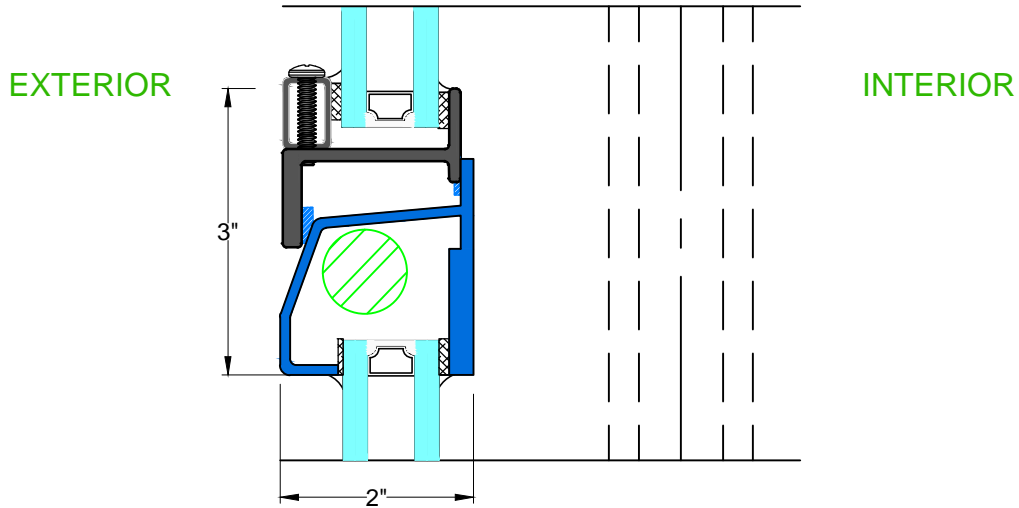

G TYPICAL LOUVER



28 Canal Street, Ellenville, NY 12428
Phone (845) 647-1900

DETENTION

Typical Details

DET 9000 SERIES

Scale: Half

PAGE 8 OF 8

EXTERIOR

INTERIOR

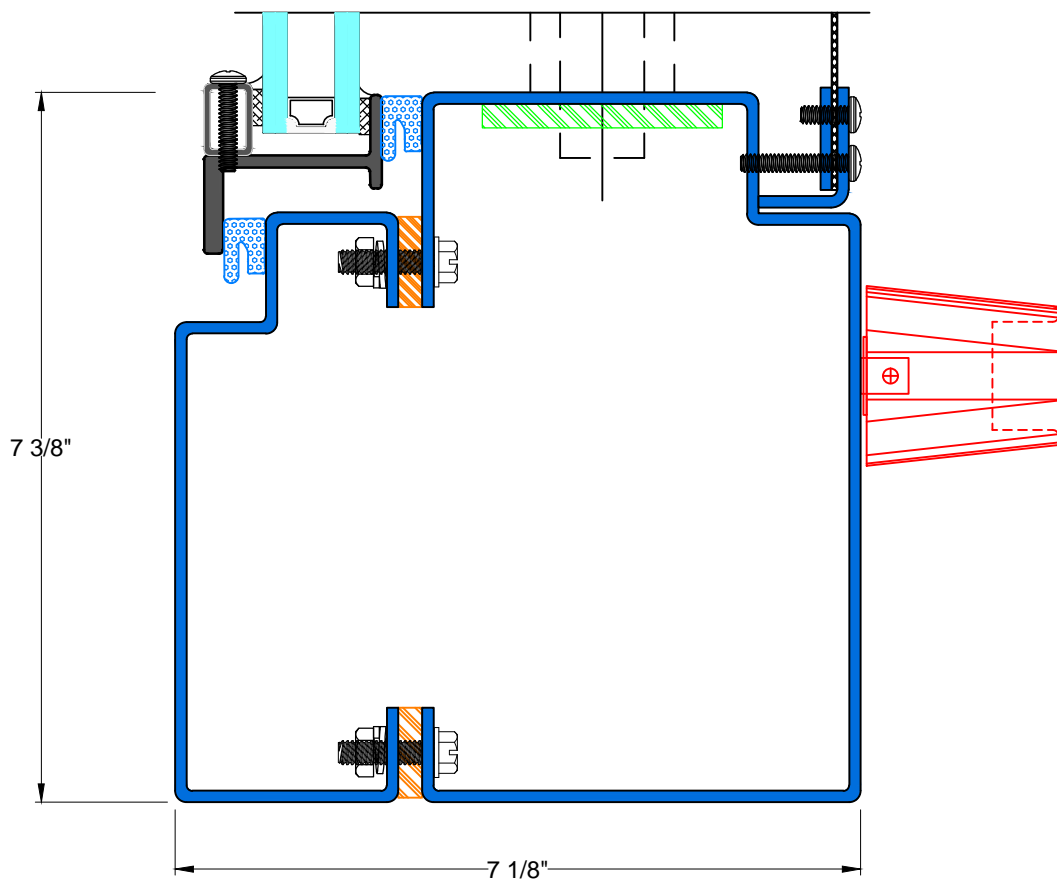

H TYPICAL SEAL



28 Canal Street, Ellenville, NY 12428
Phone (845) 647-1900